



## 5.1ch Home Theater System

# HT-S3200

AV Receiver (HT-R370)

Speaker Package (HTP-370)

## Instruction Manual

Thank you for purchasing an Onkyo 5.1ch Home Theater System. Please read this manual thoroughly before making connections and plugging in the unit. Following the instructions in this manual will enable you to obtain optimum performance and listening enjoyment from your new 5.1ch Home Theater System.

Please retain this manual for future reference.

## Contents

Introduction .....	2
Connection .....	15
Turning On & First Time Setup ...	35
Basic Operations.....	38
Using the Listening Modes .....	47
Advanced Setup .....	52
Controlling Other Components...	60
Others.....	66

## WARNING:

TO REDUCE THE RISK OF FIRE OR ELECTRIC SHOCK, DO NOT EXPOSE THIS APPARATUS TO RAIN OR MOISTURE.

## CAUTION:

TO REDUCE THE RISK OF ELECTRIC SHOCK, DO NOT REMOVE COVER (OR BACK). NO USER-SERVICEABLE PARTS INSIDE. REFER SERVICING TO QUALIFIED SERVICE PERSONNEL.



**WARNING**  
RISK OF ELECTRIC SHOCK  
DO NOT OPEN

**AVIS**  
RISQUE DE CHOC ELECTRIQUE  
NE PAS OUVRIR



The lightning flash with arrowhead symbol, within an equilateral triangle, is intended to alert the user to the presence of uninsulated “dangerous voltage” within the product’s enclosure that may be of sufficient magnitude to constitute a risk of electric shock to persons.



The exclamation point within an equilateral triangle is intended to alert the user to the presence of important operating and maintenance (servicing) instructions in the literature accompanying the appliance.

## Important Safety Instructions

1. Read these instructions.
2. Keep these instructions.
3. Heed all warnings.
4. Follow all instructions.
5. Do not use this apparatus near water.
6. Clean only with dry cloth.
7. Do not block any ventilation openings. Install in accordance with the manufacturer’s instructions.
8. Do not install near any heat sources such as radiators, heat registers, stoves, or other apparatus (including amplifiers) that produce heat.
9. Do not defeat the safety purpose of the polarized or grounding-type plug. A polarized plug has two blades with one wider than the other. A grounding type plug has two blades and a third grounding prong. The wide blade or the third prong are provided for your safety. If the provided plug does not fit into your outlet, consult an electrician for replacement of the obsolete outlet.
10. Protect the power cord from being walked on or pinched particularly at plugs, convenience receptacles, and the point where they exit from the apparatus.
11. Only use attachments/accessories specified by the manufacturer.
12. Use only with the cart, stand, tripod, bracket, or table specified by the manufacturer, or sold with the apparatus. When a cart is used, use caution when moving the cart/apparatus combination to avoid injury from tip-over.
13. Unplug this apparatus during lightning storms or when unused for long periods of time.
14. Refer all servicing to qualified service personnel. Servicing is required when the apparatus has been damaged in any way, such as power-supply cord or plug is damaged, liquid has been spilled or objects have fallen into the apparatus, the apparatus has been exposed to rain or moisture, does not operate normally, or has been dropped.
15. Damage Requiring Service  
Unplug the apparatus from the wall outlet and refer servicing to qualified service personnel under the following conditions:
  - A. When the power-supply cord or plug is damaged,
  - B. If liquid has been spilled, or objects have fallen into the apparatus,
  - C. If the apparatus has been exposed to rain or water,
  - D. If the apparatus does not operate normally by following the operating instructions. Adjust only those controls that are covered by the operating instructions as an improper adjustment of other controls may result in damage and will often require extensive work by a qualified technician to restore the apparatus to its normal operation,
  - E. If the apparatus has been dropped or damaged in any way, and
  - F. When the apparatus exhibits a distinct change in performance this indicates a need for service.
16. Object and Liquid Entry  
Never push objects of any kind into the apparatus through openings as they may touch dangerous voltage points or short-out parts that could result in a fire or electric shock.  
The apparatus shall not be exposed to dripping or splashing and no objects filled with liquids, such as vases shall be placed on the apparatus.  
Don’t put candles or other burning objects on top of this unit.
17. Batteries  
Always consider the environmental issues and follow local regulations when disposing of batteries.
18. If you install the apparatus in a built-in installation, such as a bookcase or rack, ensure that there is adequate ventilation.  
Leave 20 cm (8") of free space at the top and sides and 10 cm (4") at the rear. The rear edge of the shelf or board above the apparatus shall be set 10 cm (4") away from the rear panel or wall, creating a flue-like gap for warm air to escape.

PORTABLE CART WARNING



S3125A

# Precautions

---

1. **Recording Copyright**—Unless it's for personal use only, recording copyrighted material is illegal without the permission of the copyright holder.
2. **AC Fuse**—The AC fuse inside the unit is not user-serviceable. If you cannot turn on the unit, contact your Onkyo dealer.
3. **Care**—Occasionally you should dust the unit all over with a soft cloth. For stubborn stains, use a soft cloth dampened with a weak solution of mild detergent and water. Dry the unit immediately afterwards with a clean cloth. Don't use abrasive cloths, thinners, alcohol, or other chemical solvents, because they may damage the finish or remove the panel lettering.

## 4. Power

### WARNING

BEFORE PLUGGING IN THE UNIT FOR THE FIRST TIME, READ THE FOLLOWING SECTION CAREFULLY.

AC outlet voltages vary from country to country. Make sure that the voltage in your area meets the voltage requirements printed on the unit's rear panel (e.g., AC 230 V, 50 Hz or AC 120 V, 60 Hz).

The power cord plug is used to disconnect this unit from the AC power source. Make sure that the plug is readily operable (easily accessible) at all times.

For North American model

Pressing the [ON/STANDBY] button to select Standby mode does not fully shutdown the unit. If you do not intend to use the unit for an extended period, remove the power cord from the AC outlet.

## 5. Preventing Hearing Loss

### Caution

Excessive sound pressure from earphones and headphones can cause hearing loss.

## 6. Batteries and Heat Exposure

### Warning

Batteries (battery pack or batteries installed) shall not be exposed to excessive heat as sunshine, fire or the like.

7. **Never Touch this Unit with Wet Hands**—Never handle this unit or its power cord while your hands are wet or damp. If water or any other liquid gets inside this unit, have it checked by your Onkyo dealer.

## 8. Handling Notes

- If you need to transport this unit, use the original packaging to pack it how it was when you originally bought it.
- Do not leave rubber or plastic items on this unit for a long time, because they may leave marks on the case.
- This unit's top and rear panels may get warm after prolonged use. This is normal.
- If you do not use this unit for a long time, it may not work properly the next time you turn it on, so be sure to use it occasionally.

## For U.S. models

### FCC Information for User

#### CAUTION:

The user changes or modifications not expressly approved by the party responsible for compliance could void the user's authority to operate the equipment.

#### NOTE:

This equipment has been tested and found to comply with the limits for a Class B digital device, pursuant to Part 15 of the FCC Rules. These limits are designed to provide reasonable protection against harmful interference in a residential installation.

This equipment generates, uses and can radiate radio frequency energy and, if not installed and used in accordance with the instructions, may cause harmful interference to radio communications. However, there is no guarantee that interference will not occur in a particular installation. If this equipment does cause harmful interference to radio or television reception, which can be determined by turning the equipment off and on, the user is encouraged to try to correct the interference by one or more of the following measures:

- Reorient or relocate the receiving antenna.
- Increase the separation between the equipment and receiver.
- Connect the equipment into an outlet on a circuit different from that to which the receiver is connected.
- Consult the dealer or an experienced radio/TV technician for help.

## For Canadian Models

**NOTE:** THIS CLASS B DIGITAL APPARATUS COMPLIES WITH CANADIAN ICES-003.

For models having a power cord with a polarized plug:

**CAUTION:** TO PREVENT ELECTRIC SHOCK, MATCH WIDE BLADE OF PLUG TO WIDE SLOT, FULLY INSERT.

## Modèle pour les Canadien

**REMARQUE:** CET APPAREIL NUMÉRIQUE DE LA CLASSE B EST CONFORME À LA NORME NMB-003 DU CANADA.

Sur les modèles dont la fiche est polarisée:

**ATTENTION:** POUR ÉVITER LES CHOCS ÉLECTRIQUES, INTRODUIRE LA LAME LA PLUS LARGE DE LA FICHE DANS LA BORNE CORRESPONDANTE DE LA PRISE ET POUSSER JUSQU'AU FOND.

# Speaker Precautions

---

## ***Placement***

---

- The subwoofer cabinet is made out of wood and is therefore sensitive to extreme temperatures and humidity, do not put it in locations subject to direct sunlight or in humid places, such as near an air conditioner, humidifier, bathroom, or kitchen.
- Do not put water or other liquids close to the speakers. If liquid is spilled over the speakers, the drive units may be damaged.
- Speakers should only be placed on sturdy, flat surfaces that are free from vibration. Putting them on uneven or unstable surfaces, where they may fall and cause damage, will affect the sound quality.
- Subwoofer is designed to be used in the upright vertical position only. Do not use it in the horizontal or tilted position.
- If the unit is used near a turntable, CD player or DVD/BD player, howling or slipping of sound may occur. To prevent this, move the unit away from the turntable, CD player or DVD/BD player, otherwise lower the unit's output level.

## ***Using Close to a TV or Computer***

---

TVs and computer monitors are magnetically sensitive devices and as such are likely to suffer discoloration or picture distortion when conventional speakers are placed nearby. To prevent this, the SKF-370 and SKC-370/SKC-370C feature internal magnetic shielding. In some situations, however, discoloration may still be an issue, in which case you should turn off your TV or monitor, wait 15 to 30 minutes, and then turn it back on again. This normally activates the degaussing function, which neutralizes the magnetic field, thereby removing any discoloration effects. If discoloration problems persist, try moving the speakers away from your TV or monitor. Note that discoloration can also be caused by a magnet or demagnetizing tool that's too close to your TV or monitor.

Do not place SKR-370 close to TV or a computer monitor because they have no magnetic shield.

## ***Input Signal Warning***

---

The speakers can handle the specified input power when used for normal music reproduction. If any of the following signals are fed to them, even if the input power is within the specified rating, excessive current may flow in the speaker coils, causing burning or wire breakage:

1. Interstation noise from an untuned FM radio.
2. Sound from fast-forwarding a cassette tape.
3. High-pitched sounds generated by an oscillator, electronic musical instrument, and so on.
4. Amplifier oscillation.
5. Special test tones from audio test CDs and so on.
6. Thumps and clicks caused by connecting or disconnecting audio cables (Always turn off your amplifier before connecting or disconnecting cables.)
7. Microphone feedback.

# Contents

Introduction	
Important Safety Instructions .....	2
Precautions .....	3
Speaker Precautions.....	4
Package Contents.....	5
Features.....	7
Front & Rear Panels.....	8
Speaker Package.....	12
Remote Controller.....	13
Connections	
Enjoying Home Theater .....	15
Connecting the AV receiver .....	16
Turning on & First Time Setup	
Turning On the AV receiver.....	35
First Time Setup.....	36
Basic Operations	
Basic Operations.....	38
Listening to the Radio .....	42
Recording.....	46
Using the Listening Modes	
Using the Listening Modes.....	47
Advanced Setup	
Advanced Setup.....	52
Controlling Other Components	
Controlling Other Components.....	60
Others	
Troubleshooting .....	66
Specifications .....	69

\* To reset the AV receiver to its factory defaults, turn it on and, while holding down the [VCR/DVR] button, press the [ON/STANDBY] button (see page 66).

# Package Contents

Make sure you have the following items:

## AV receiver HT-R370

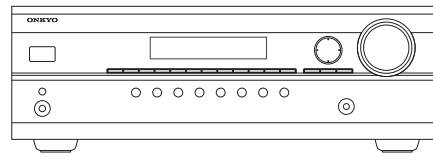

HT-R370

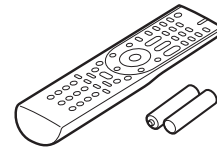

Remote controller and two batteries (AA/R6)



Indoor FM antenna

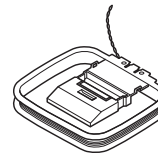

AM loop antenna

\* In catalogs and on packaging, the letter at the end of the product name indicates the color. Specifications and operations are the same regardless of color.

## Package Contents—Continued

### Speaker Package HTP-370

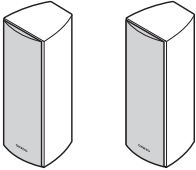
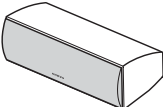
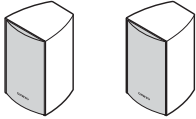
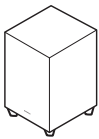
	<b>Front speakers (SKF-370 L/R)</b>
	<b>Center speaker (SKC-370/SKC-370C)</b>
	<b>Surround speakers (SKR-370 L/R)</b>
	<b>Subwoofer (SKW-370)</b>

### Speaker Package Accessories

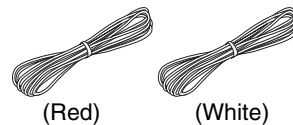

**Speaker cable for front speakers 11 ft. (3.5 m)**

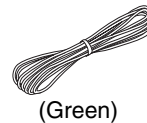

**Speaker cable for center speaker 10 ft. (3 m)**

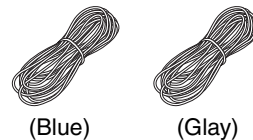

**Speaker cables for surround speakers 26 ft. (8 m)**

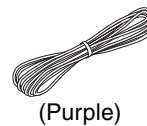

**Speaker cables for subwoofer 13 ft. (4 m)**



**16 thin rubber stoppers, 12 thick rubber stoppers**



**4 floor pads for the subwoofer**

# Features

## HT-R370 AV Receiver

- 110 Watts/Channel @ 6 ohms
- 100 Watts/Channel @ 6 ohms (IEC)
- 120 Watts/Channel @ 6 ohms (JEITA)
- H.C.P.S. (High Current Power Supply) Massive High Power Transformer
- Dolby Digital and Pro Logic II<sup>\*1</sup>
- DTS and DTS Neo:6 5.1<sup>\*2</sup>
- Music Optimizer<sup>\*3</sup> for Digital Audio Files
- CinemaFILTER
- 3 HDMI<sup>\*4</sup> Inputs and 1 Output (Pass-Thru)
- Component Video Switching (2 Inputs/1 Output)
- Front “Portable” Input for iPod<sup>®\*</sup> and MP3 Players
- 3 Digital Inputs (2 Optical/1 Coaxial)
- Speaker A/ B Drive
- Banana Plug-Compatible Speaker Posts (Front Speaker-A Only)
- Color-Coded Speaker Terminals
- Audyssey EQ<sup>\*5</sup> to Correct Room Acoustic Problems
- Audyssey Dynamic EQ<sup>\*5</sup> for Loudness Correction
- Audyssey Dynamic Volume<sup>\*5</sup> to Maintain Optimal Listening Level and Dynamic Range
- EX.BASS for natural deeper bass
- Crossover Adjustment (40/50/60/80/100/120/150/200Hz)
- A/V Sync Control (up to 100 ms in 20 ms Steps)
- Theater Dimensional Virtual Surround Function<sup>\*6</sup>
- RI-Compatible Remote Control



Manufactured under license from Dolby Laboratories. “Dolby”, “Pro Logic” and the double-D symbol are trademarks of Dolby Laboratories.



Manufactured under license under U.S. Patent #'s: 5,451,942; 5,956,674; 5,974,380; 5,978,762; 6,226,616; 6,487,535; 7,003,467 & other U.S. and worldwide patents issued & pending.

DTS, DTS Digital Surround, and Neo: 6 are registered trademarks and the DTS logos, Symbol and DTS 96/24 are trademarks of DTS, Inc.

© 1996-2008 DTS, Inc. All Rights Reserved.

<sup>\*3</sup> Music Optimizer<sup>™</sup> is a trademark of Onkyo Corporation.



HDMI, the HDMI logo and High Definition Multimedia Interface are trademarks or registered trademarks of HDMI Licensing, LLC.



Manufactured under license from Audyssey Laboratories. U.S. and foreign patents pending.

Audyssey EQ<sup>™</sup>, Audyssey Dynamic Volume<sup>™</sup>, and Audyssey Dynamic EQ<sup>™</sup> are trademarks of Audyssey Laboratories.



Theater-Dimensional is a trademark of Onkyo Corporation.

\* Apple and iPod are trademarks of Apple Inc., registered in the U.S. and other countries.

## HTP-370 Speaker Package

### SKF-370 L/R Full-Range Front Speakers

### SKC-370 Full-Range Center Speaker

#### (North American model)

- 3-1/4" (8 cm) full-range speaker
- Gloss Finished
- Max. input power:120 W
- Magnetically shielded
- Color-coded speaker terminals and speaker cable
- 6-ohm impedance

### SKC-370C Full-Range Center Speaker (Asian model)

- 3-1/4" (8 cm) full-range speaker × 2
- Gloss Finished
- Max. input power:120 W
- Magnetically shielded
- Color-coded speaker terminals and speaker cable
- 6-ohm impedance

### SKR-370 L/R Full-Range Surround Speakers

- 3-1/4" (8 cm) full-range speaker
- Max. input power:120 W
- Gloss Finished
- 6-ohm impedance
- Color-coded speaker terminals and speaker cable

### SKW-370 Bass Reflex Subwoofer

- 8" (20 cm) cone woofer
- Down-Firing
- Color-coded speaker terminals and speaker cable

# Front & Rear Panels

## Front Panel

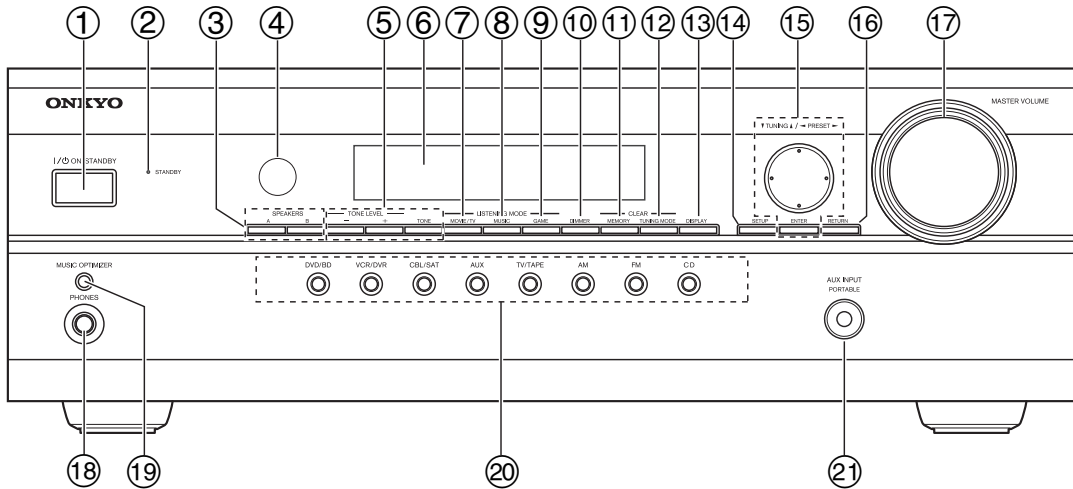

The actual front panel has various logos printed on it. They are not shown here for clarity.

The page numbers in parentheses show where you can find the main explanation for each item.

- ① **ON/STANDBY button (35)**  
Set the AV receiver to On or Standby.
- ② **STANDBY indicator (35)**  
Lights up when the AV receiver is on Standby and flashes while a signal is being received from the remote controller.
- ③ **SPEAKERS A & B buttons (15, 38)**  
Turn speaker sets A and B on or off.
- ④ **Remote control sensor (14)**  
This sensor receives control signals from the remote controller.
- ⑤ **-, +, and TONE buttons (40)**  
Used to adjust the tone (bass and treble).
- ⑥ **Display**  
See “Display” on page 9.
- ⑦ **MOVIE/TV button (47)**  
Selects the listening modes intended for use with movies and TV.
- ⑧ **MUSIC button (47)**  
Selects the listening modes intended for use with music.
- ⑨ **GAME button (47)**  
Selects the listening modes intended for use with video games.
- ⑩ **DIMMER button (39)**  
Adjusts the display brightness.
- ⑪ **MEMORY button (45)**  
Used when storing or deleting radio presets.
- ⑫ **TUNING MODE button (43)**  
Selects the Auto or Manual tuning mode for AM and FM radio.
- ⑬ **DISPLAY button (40, 44)**  
Displays various information about the currently selected input source.
- ⑭ **SETUP button**  
Opens and closes the setup menus.
- ⑮ **TUNING, PRESET, Arrow, and ENTER buttons**  
When AM or FM is selected, the TUNING [▲]/[▼] buttons are used for radio tuning, and the PRESET [◀]/[▶] buttons are used to select radio presets (see page 45). With the setup menus, they work as arrow buttons and are used to select and set items. The [ENTER] button is also used with the setup menus.
- ⑯ **RETURN button**  
Selects the previously displayed setup menu.
- ⑰ **MASTER VOLUME control (38)**  
Sets the volume of the AV receiver to Min, 1 through 79, or Max.
- ⑱ **PHONES jack (40)**  
This 1/4-inch phone jack is for connecting a standard pair of stereo headphones for private listening.
- ⑲ **MUSIC OPTIMIZER button (41, 59)**  
Turns the Music Optimizer on or off.



## Front & Rear Panels—Continued

For detailed information, see the pages in parentheses.

- ⑳ **Input selector buttons (38)**  
Select the following input sources: DVD/BD, VCR/DVR, CBL/SAT, AUX, TV/TAPE, AM, FM, CD.

- ㉑ **AUX INPUT PORTABLE (30):**  
Used to connect a portable Audio player.

### Display

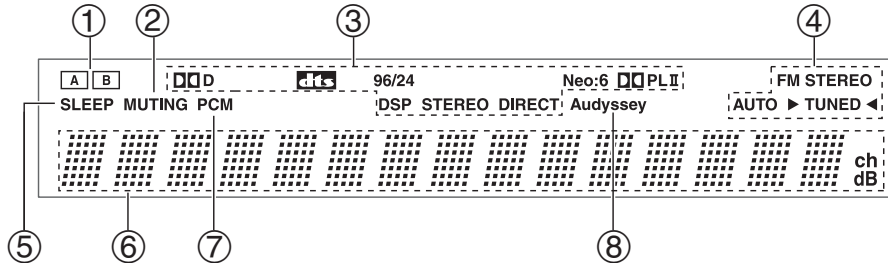

For detailed information, see the pages in parentheses.

- ① **A and B speaker indicators (15, 38)**  
Indicator A lights up when speaker set A is on.  
Indicator B lights up when speaker set B is on.
- ② **MUTING indicator (39)**  
Flashes while the AV receiver is muted.
- ③ **Listening mode and format indicators (47)**  
Show the selected listening mode and audio input signal format.
- ④ **Tuning indicators (43)**  
**FM STEREO (43):**  
Lights up when tuned to a stereo FM station.  
**AUTO (43):**  
Lights up when Auto Tuning mode is selected for AM or FM radio. Goes off when Manual Tuning mode is selected.  
**TUNED (43):**  
Lights up when tuned to a radio station.
- ⑤ **SLEEP indicator (39)**  
Lights up when the Sleep function has been set.
- ⑥ **Message area**  
Displays various information.
- ⑦ **Audio input indicators**  
Indicate the type of audio input that's selected as the audio source: PCM.
- ⑧ **Audyssey indicator (54)**  
Lights up when the "Equalizer Settings" is set to "Audyssey".

Rear Panel

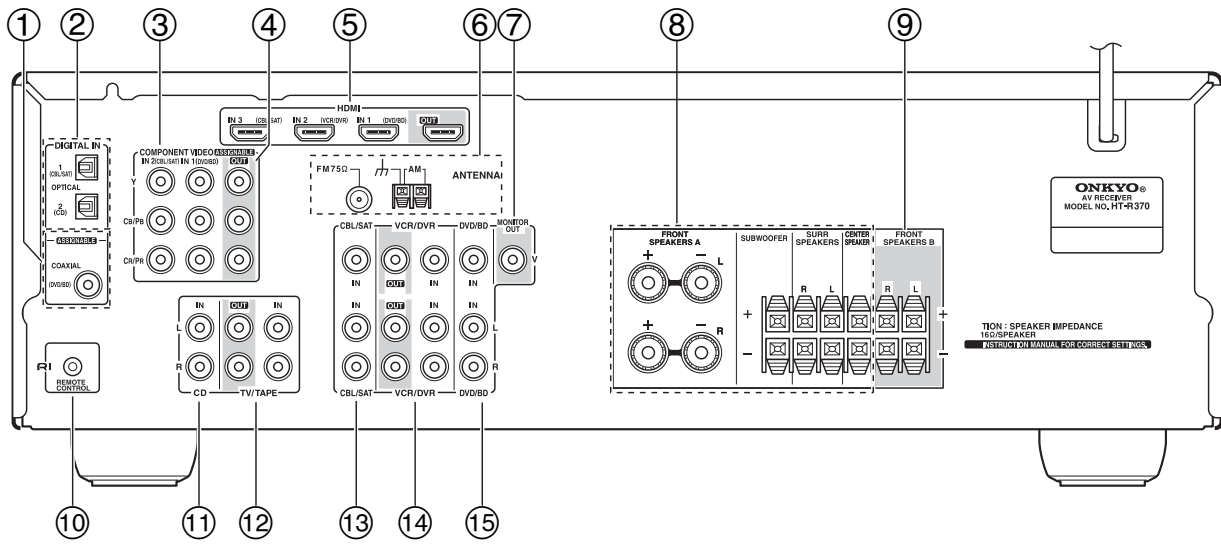

① **DIGITAL IN COAXIAL**

These coaxial digital audio inputs are for connecting components with a coaxial digital audio output, such as a CD player or DVD/BD player. They're assignable, which means you can assign each one to an input selector to suit your setup. See "Digital Input Setup" on page 36.

② **DIGITAL IN OPTICAL 1 and 2**

These optical digital audio inputs are for connecting components with an optical digital audio output, such as a CD player or DVD/BD player. They're assignable, which means you can assign each one to an input selector to suit your setup. See "Digital Input Setup" on page 36.

③ **COMPONENT VIDEO IN 1 and 2**

These RCA component video inputs are for connecting components with a component video output, such as a DVD/BD player, DVD/BD recorder, or DVR (digital video recorder). They're assignable, which means you can assign each one to an input selector to suit your setup. See "Component Video Input Setup" on page 36.

④ **COMPONENT VIDEO OUT**

This RCA component video output is for connecting a TV or projector with a component video input.

⑤ **HDMI IN 1–3 and OUT**

HDMI (High Definition Multimedia Interface) connections carry digital audio and digital video. The HDMI inputs are for connecting components with an HDMI output, such as a DVD/BD player, DVD/BD recorder, or DVR (digital video recorder). The HDMI outputs are for connecting a TV or projector with an HDMI input.

⑥ **AM and FM ANTENNA**

The AM push terminals are for connecting an AM antenna. The FM jack is for connecting an FM antenna.

⑦ **MONITOR OUT**

The composite video jack should be connected to a video input on your TV or projector.

⑧ **FRONT SPEAKERS A, CENTER, and SURR L/R SPEAKERS & SUBWOOFER**

These terminal posts and push terminals are for connecting speaker set A.

⑨ **FRONT SPEAKERS B**

These push terminals are for connecting speaker set B.

⑩ **RI REMOTE CONTROL**

This **RI** (Remote Interactive) jack can be connected to the **RI** jack on another **RI**-capable Onkyo component for remote and system control. To use **RI**, you must make an analog audio connection (RCA) between the AV receiver and the other component, even if they are connected digitally.

⑪ **CD IN**

This analog audio input is for connecting a CD player's analog audio output.

⑫ **TV/TAPE IN/OUT**

These analog audio input and output jacks are for connecting a recorder with an analog audio input and output, such as a cassette deck, MD recorder, etc.

## Front & Rear Panels—Continued

---

⑬ **CBL/SAT IN**

A cable or satellite receiver can be connected here. There is composite video input jacks for connecting the video signal, and there are analog audio input jacks for connecting the audio signal.

⑭ **VCR/DVR IN/OUT**

A video component, such as a VCR or DVR, can be connected here for recording and playback. There is composite video input and output jacks for connecting the video signal, and there are analog audio input jacks for connecting the audio signal.

⑮ **DVD/BD IN**

This input is for connecting a DVD/BD player. There is composite video input jacks for connecting the video signal, and there are analog audio input jacks for connecting the audio signal.

See pages 15–34 for hookup information.

# Speaker Package

## Front, Center, Surround, & Subwoofer speakers (SKF-370, SKC-370/SKC-370C, SKR-370, SKW-370)

### ■ Rear

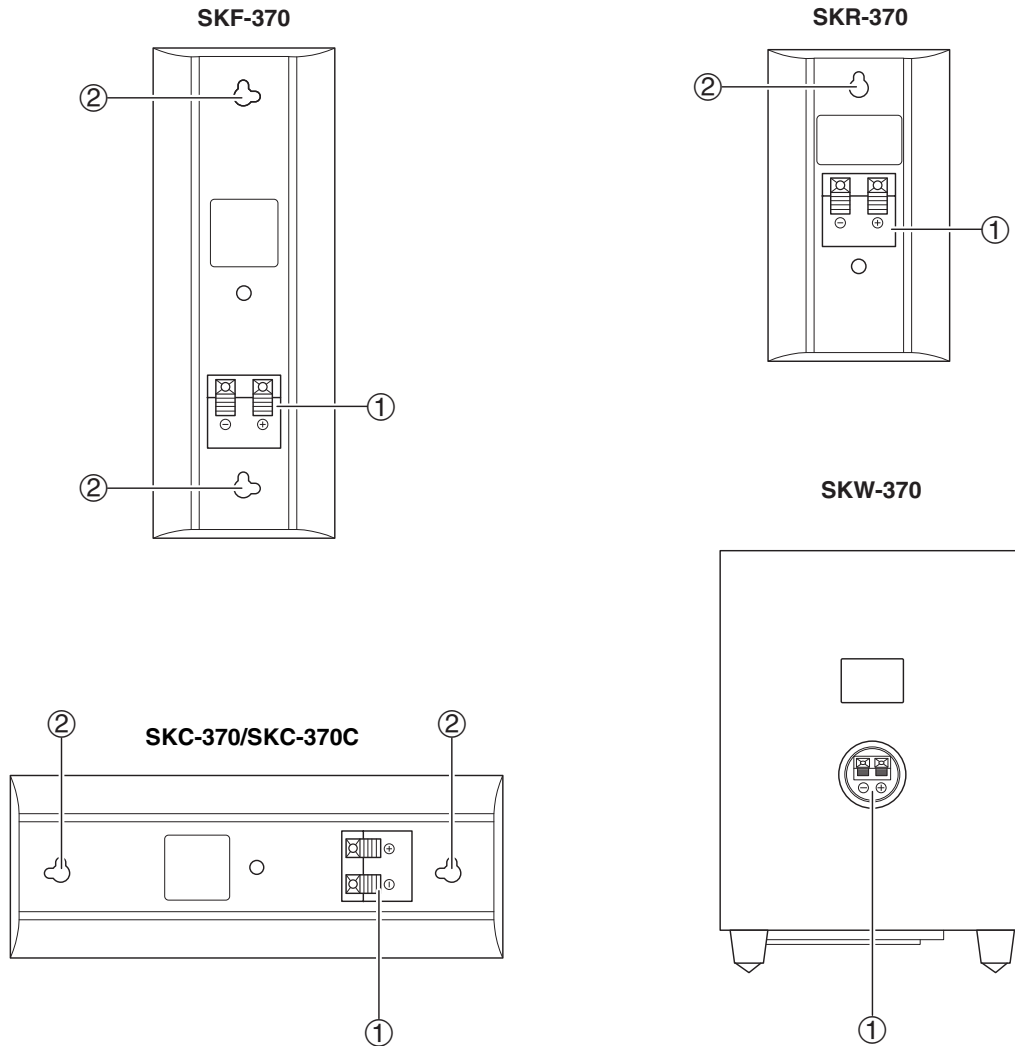

#### ① Speaker terminals

These push terminals are for connecting the speaker to the HT-R370 with the supplied speaker cables. The supplied speaker cables are color-coded for easy identification. Simply connect each cable to the same-colored positive speaker terminal.

#### ② Keyhole slots

These keyhole slots can be used to wall-mount the speaker. See page 18 for mounting instructions.

#### Caution:

The front grilles are not designed to be removed so do not attempt to remove them forcibly, as this will damage them.

# Remote Controller

## Controlling the AV receiver

To control the AV receiver, press the **[RECEIVER]** button to select Receiver mode.

You can also use the remote controller to control your DVD/BD player, CD player, and other components. See page 60 for more details.

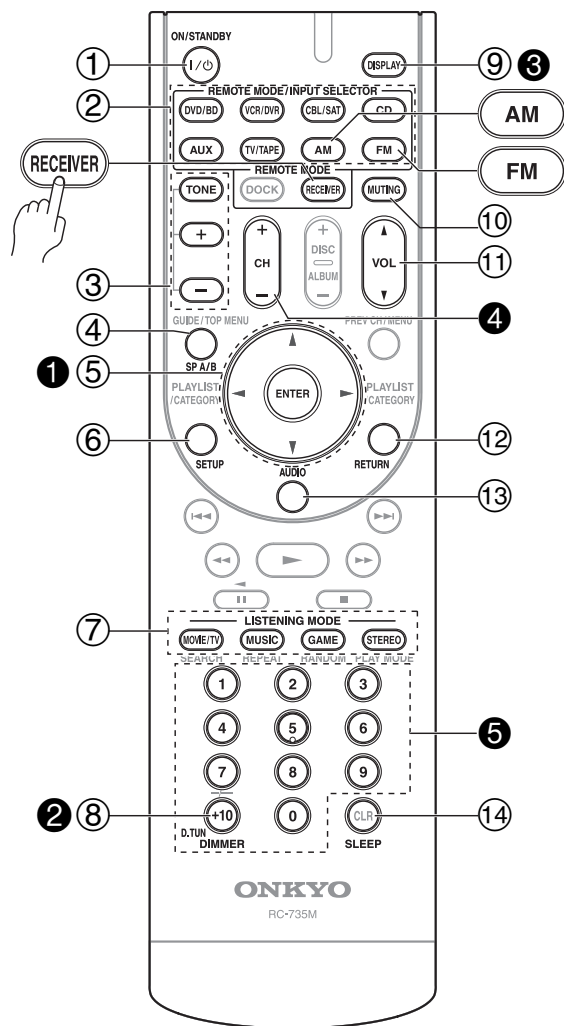

For detailed information, see the pages in parentheses.

- ① **ON/STANDBY button (35)**  
Sets the AV receiver to On or Standby.
- ② **REMOTE MODE/INPUT SELECTOR buttons (38, 62–65)**  
Selects the remote controller modes and the input sources.
- ③ **TONE, +, and – buttons (40)**  
Used to adjust the tone (bass and treble).

- ④ **SP A/B button (15, 38)**  
This button is used to turn speaker sets A and B on or off.
- ⑤ **Arrow [▲]/[▼]/[◀]/[▶] and ENTER buttons**  
Used to select and adjust settings.
- ⑥ **SETUP button**  
Used to change settings.
- ⑦ **LISTENING MODE buttons (47)**  
Used to select the listening modes.
- ⑧ **DIMMER button (39)**  
Adjusts the display brightness.
- ⑨ **DISPLAY button (40)**  
Displays information about the current input source.
- ⑩ **MUTING button (39)**  
Mutes or unmutes the AV receiver.
- ⑪ **VOL [▲]/[▼] button (38)**  
Adjusts the volume of the AV receiver regardless of the currently selected remote controller mode.
- ⑫ **RETURN button**  
Returns to the previous display when changing settings.
- ⑬ **AUDIO button (41, 58)**  
Used to change audio settings.
- ⑭ **SLEEP button (39)**  
Used with the Sleep function.

### ■ Controlling the tuner

To control the AV receiver's tuner, press the **[AM]**, **[FM]** button.

- ① **Arrow [▲]/[▼] buttons**  
Used to tune into radio stations.
- ② **D.TUN button (44)**  
Selects the Direct tuning mode.
- ③ **DISPLAY button (44)**  
Displays information about the band, frequency, preset number, and so on.
- ④ **CH +/- button (45)**  
Selects radio presets.
- ⑤ **Number buttons (44)**  
Used to select AM and FM radio stations directly (In the Direct tuning mode).

### Note:

An Onkyo cassette recorder connected via **RI** can also be controlled in Receiver mode (see page 65).

### Installing the Batteries

- 1 To open the battery compartment, press the small lever and remove the cover.**

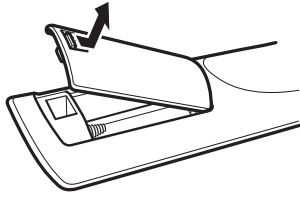

- 2 Insert the two supplied batteries (AA/R6) in accordance with the polarity diagram inside the battery compartment.**

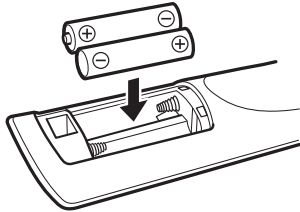

- 3 Replace the cover and push it shut.**

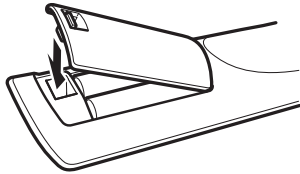

#### Notes:

- If the remote controller doesn't work reliably, try replacing the batteries.
- Don't mix new and old batteries or different types of batteries.
- If you intend not to use the remote controller for a long time, remove the batteries to prevent damage from leakage or corrosion.
- Expired batteries should be removed as soon as possible to prevent damage from leakage or corrosion.

### Aiming the Remote Controller

When using the remote controller, point it toward the AV receiver's remote control sensor, as shown below.

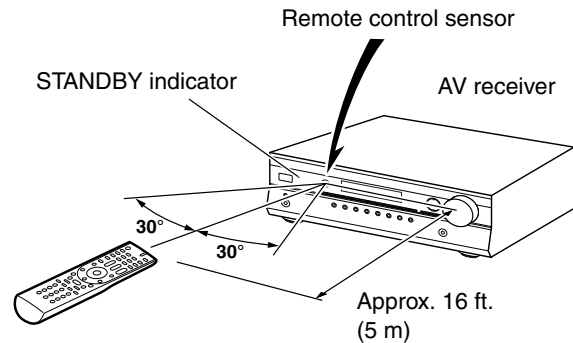

#### Notes:

- The remote controller may not work reliably if the AV receiver is subjected to bright light, such as direct sunlight or inverter-type fluorescent lights. Keep this in mind when installing.
- If another remote controller of the same type is used in the same room, or the AV receiver is installed close to equipment that uses infrared rays, the remote controller may not work reliably.
- Don't put anything on top of the remote controller, such as a book or magazine, because a button may be pressed continuously, thereby draining the batteries.
- The remote controller may not work reliably if the AV receiver is installed in a rack behind colored glass doors. Keep this in mind when installing.
- The remote controller will not work if there's an obstacle between it and the AV receiver's remote control sensor.

# Enjoying Home Theater

## Speaker Sets A and B

You can use two sets of speakers with the AV receiver: *speaker set A* and *speaker set B*.

**Speaker set A** should be used in your main listening room for up to 5.1-channel playback.

\* While speaker set B is on, speaker set A is reduced to 2.1-channel playback.

**Speaker set B** can be used in another room and offers 2-channel stereo playback.

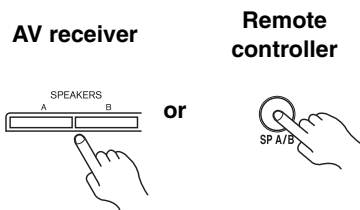

Speaker set A	Speaker set B	Indicator	Output
On	On	A B	Set A: 2.1 channels Set B: 2 channels
	Off	A	Set A: 5.1 channels
Off	On	B	Set B: 2 channels
	Off		No sound

### Speaker Set A: Main Room

#### Center speaker (SKC-370/SKC-370C)

This speaker enhances the front left and right speakers, making sound movements distinct and providing a full sound image. For movies it's used mainly for dialog. Position it close to your TV facing forward at about ear level, or at the same height as the front left and right speakers.

\* While speaker set B is on, this speaker outputs no sound.

#### Subwoofer (SKW-370)

The subwoofer handles the bass sounds of the LFE (Low-Frequency Effects) channel. In general, a good bass sound can be obtained by installing the subwoofer in a front corner, or at one-third the way along the wall, as shown.

**Tip:** To find the best position for your subwoofer, while playing a movie or some music with good bass, experiment by placing your subwoofer at various positions within the room and choose the one that provides the most satisfying results.

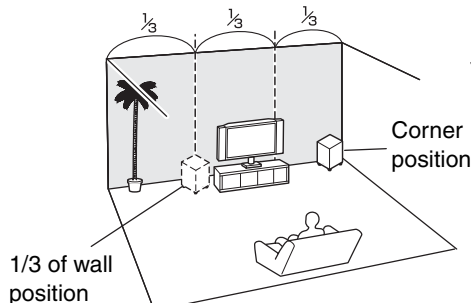

#### Front left and right speakers (SKF-370 L/R)

These output the overall sound. Their role in a home theater is to provide a solid anchor for the sound image. They should be positioned facing the listener at about ear level, and equally spaced from the TV. Angle them inward.

HTP-370 speaker package is shown

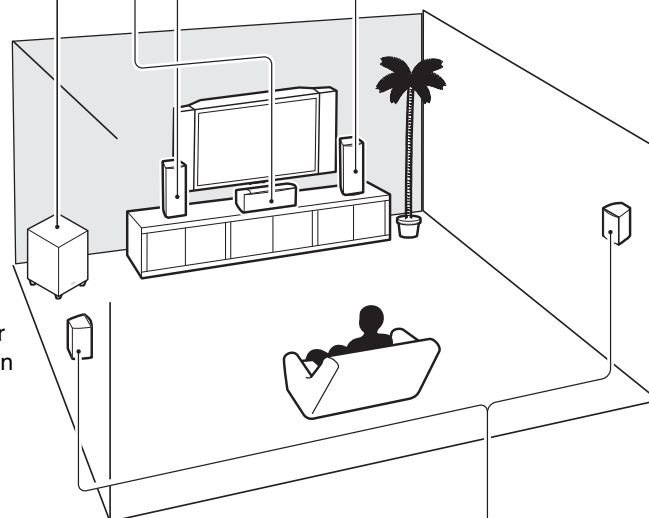

### Speaker Set B: Sub Room

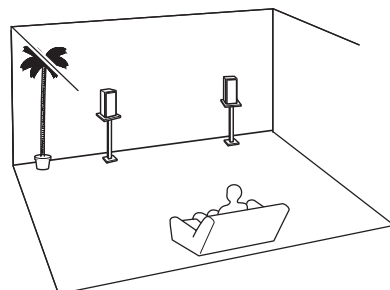

#### Surround left and right speakers (SKR-370 L/R)

These speakers are used for precise sound positioning and to add realistic ambience. Position them at the sides of the listener, or slightly behind, about 2–3 feet (60–100 cm) above ear level. Ideally they should be equally spaced from the listener.

\* While speaker set B is on, these speakers output no sound.

# Connecting the AV receiver

## Connecting Your Speakers

### Speaker Connection Precautions

Read the following before connecting your speakers:

- You can connect speakers with an impedance of **6 ohms or higher**. If you use speakers with a lower impedance, and use the amplifier at high volume levels for a long period of time, the built-in protection circuit may be activated.
- Disconnect the power cord from the wall outlet before making any connections.
- Read the instructions supplied with your speakers.
- Pay close attention to speaker wiring polarity. Connect positive (+) terminals to only positive (+) terminals, and negative (-) terminals to only negative (-) terminals. If you get them the wrong way around, the sound will be out of phase and will sound unnatural.
- Unnecessarily long or very thin speaker cables may affect the sound quality and should be avoided.
- Be careful not to short the positive and negative wires. Doing so may damage the AV receiver.

#### FRONT SPEAKERS A

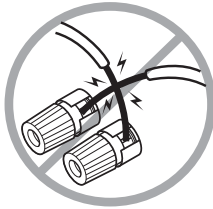

- Don't connect more than one cable to each speaker terminal. Doing so may damage the AV receiver.
- Don't connect a speaker to several terminals.

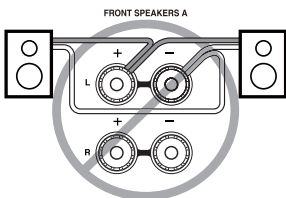

#### OTHERS

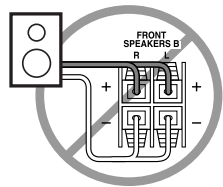
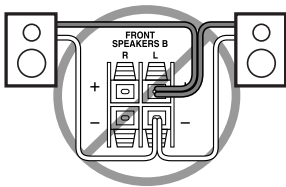
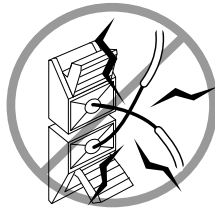

#### For North American model

- If you are using banana plugs, tighten the speaker terminal before inserting the banana plug.
- Do not insert the speaker code directly into the center hole of the speaker terminal.

## Connecting the Speaker Cables

The AV receiver's positive (+) speaker terminals are color-coded for ease of identification. (The negative (-) speaker terminals are all black.)

Speaker	Color
Front left	White
Front right	Red
Center	Green
Surround left	Blue
Surround right	Gray
Subwoofer	Purple

### FRONT SPEAKERS A

- 1 Strip about 5/8" (15 mm) of insulation from the ends of the speaker cables. (Supplied speaker cables are already stripped.)

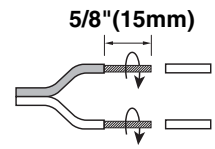

- 2 Unscrew the terminal.



- 3 Fully insert the bare wire.



- 4 Screw the terminal tight.





# Connecting the AV receiver—Continued

## OTHERS

- 1 Strip 3/8" (10 mm) of insulation from the ends of the speaker cables. (Supplied speaker cables are already stripped.)

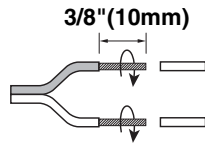

- 2 While pressing the lever, insert the wire into the hole, and then release the lever. Make sure that the terminals are gripping the bare wires, not the insulation.

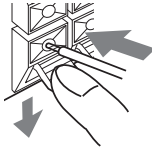

The following illustration shows which speaker should be connected to each pair of terminals.

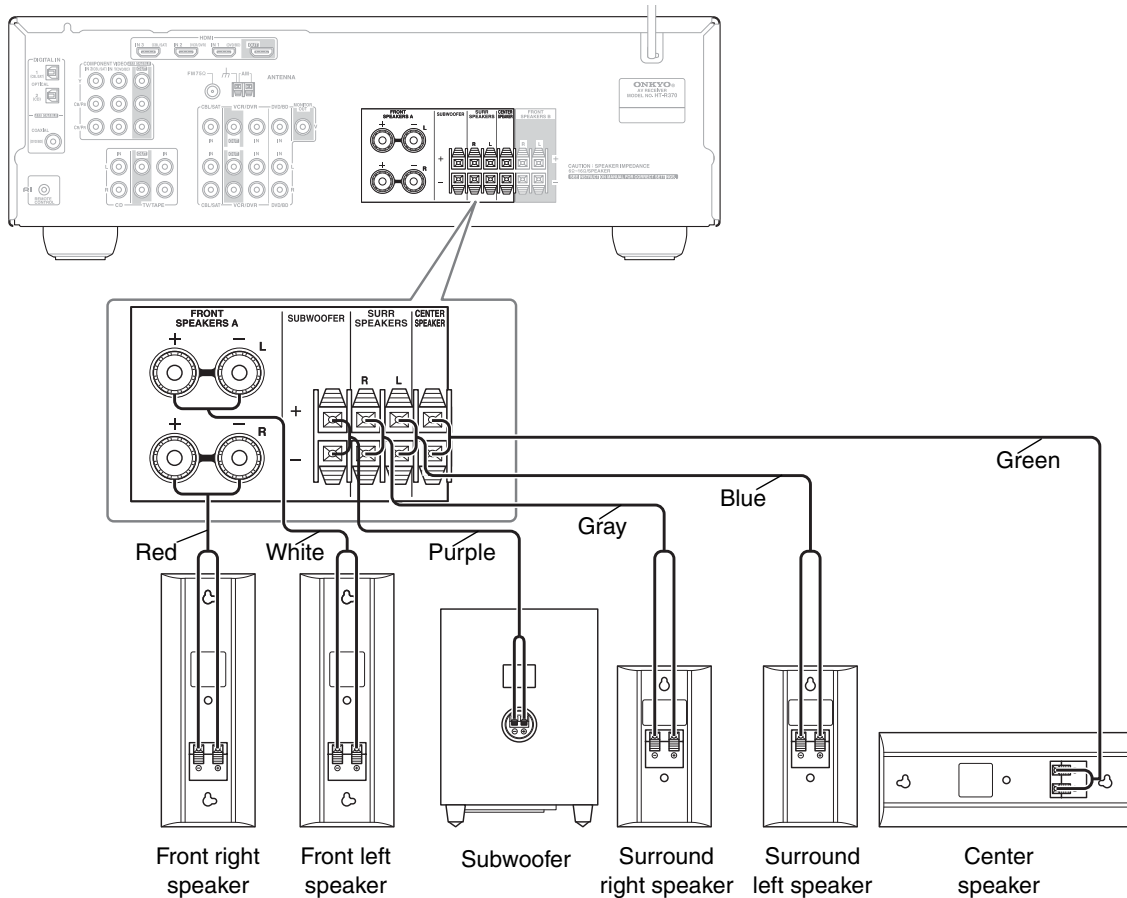

## Connecting the AV receiver—Continued

### Wall Mounting

The speakers can easily be wall mounted by using the keyhole slots. To prevent the speaker from vibrating against the wall, attach two of the supplied thick rubber stoppers to the rear of each speaker.

To mount the front or surround speakers vertically, use the keyhole slot shown to hang each speaker on a screw that's securely screwed into the wall.

#### Front speakers (SKF-370)

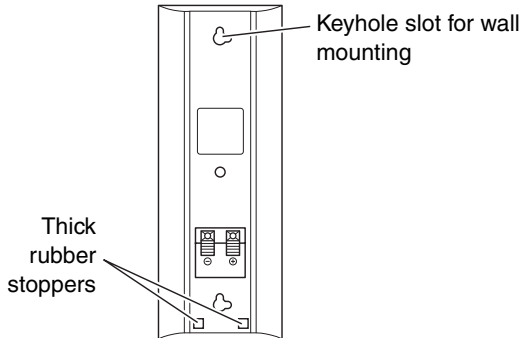

#### Surround speakers (SKR-370)

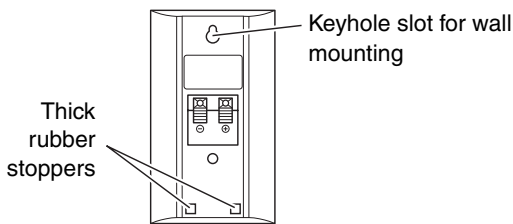

To mount the center speaker horizontally, use the two keyhole slots shown to hang each speaker on two screws that are securely screwed into the wall.

#### Center speaker (SKC-370/SKC-370C)

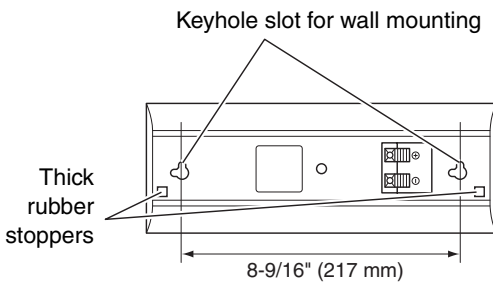

#### Caution:

A mounting screw's ability to support a speaker depends on how well it's anchored to the wall. If you have hollow walls, screw each mounting screw into a stud. If there are no studs, or the walls are solid, use suitable wall anchors. Use screws with a head diameter of 5/16" (9 mm) or less and a shank diameter of 1/8" (4 mm) or less. With hollow walls, use a cable/pipe detector to check for any power cables or water pipes before making any holes.

Leave a gap of between 3/16" (5 mm) and 7/16" (10 mm) between the wall and the base of the screw head, as shown. (We recommend that you consult a home installation professional.)

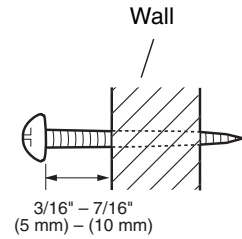

### Using the Rubber Stoppers for a More Stable Platform

We recommend using the provided rubber stoppers to achieve the best possible sound from your speakers. The rubber stoppers prevent the speakers from moving, providing a more stable platform. Use thick stoppers for the center speaker, and thin stoppers for the other speakers.

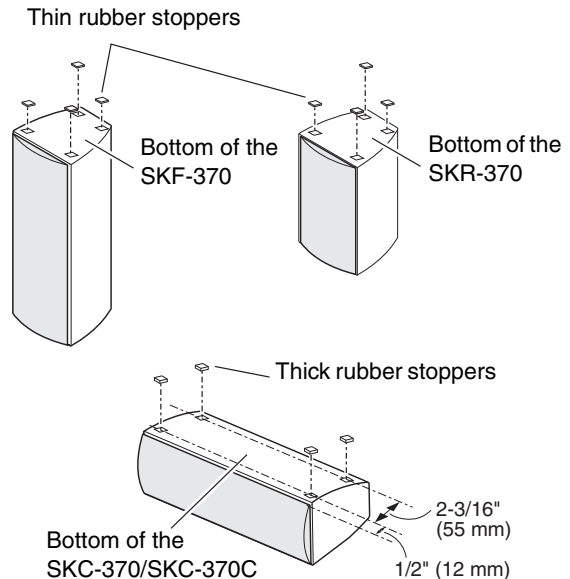

### Using the Floor Pads for Subwoofer

If the subwoofer is placed on a hard floor (wood, vinyl, tile, etc.) and playback is very loud, the subwoofer's feet may damage the flooring. To prevent this, place the supplied pads underneath the subwoofer's feet. The pads also provide a stable base for the subwoofer.

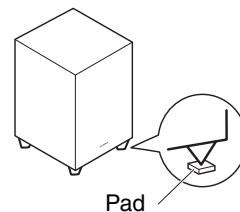

## Connecting the AV receiver—Continued

### Connecting Antenna

This section explains how to connect the supplied indoor FM antenna and AM loop antenna, and how to connect commercially available outdoor FM and AM antennas. The AV receiver won't pick up any radio signals without any antenna connected, so you must connect the antenna to use the tuner.

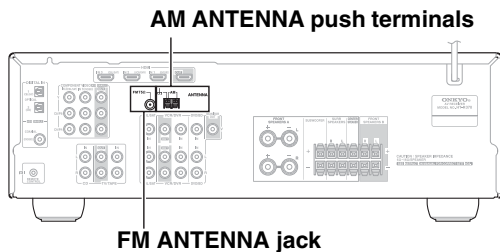

### Connecting the Indoor FM Antenna

The supplied indoor FM antenna is for indoor use only.

#### 1 Attach the FM antenna, as shown.

##### ■ North American Model

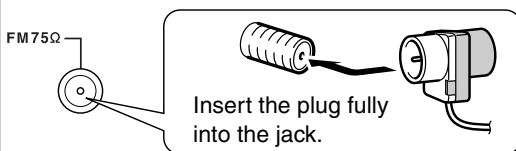

##### ■ Asian Models

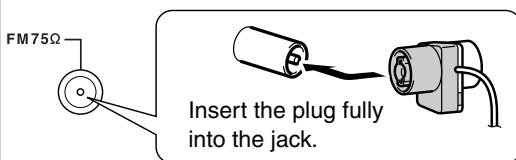

Once your AV receiver is ready for use, you'll need to tune into an FM radio station and adjust the position of the FM antenna to achieve the best possible reception.

#### 2 Use thumbtacks or something similar to fix the FM antenna into position.

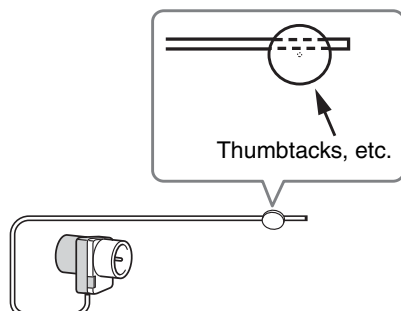

##### Caution:

Be careful that you don't injure yourself when using thumbtacks.

If you cannot achieve good reception with the supplied indoor FM antenna, try a commercially available outdoor FM antenna instead (see page 20).

### Connecting the AM Loop Antenna

The supplied indoor AM loop antenna is for indoor use only.

#### 1 Assemble the AM loop antenna, inserting the tabs into the base, as shown.

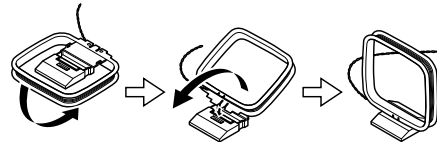

#### 2 Connect both wires of the AM loop antenna to the AM push terminals, as shown.

(The antenna's wires are not polarity sensitive, so they can be connected either way around.)

Make sure that the wires are attached securely and that the push terminals are gripping the bare wires, not the insulation.

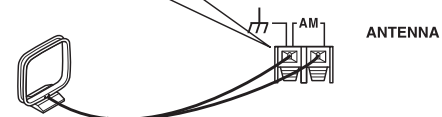
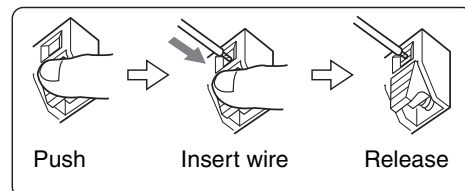

Once your AV receiver is ready for use, you'll need to tune into an AM radio station and adjust the position of the AM antenna to achieve the best possible reception.

Keep the antenna as far away as possible from your AV receiver, TV, speaker cables, and power cords.

If you cannot achieve good reception with the supplied indoor AM loop antenna, try using it with a commercially available outdoor AM antenna (see page 20).

## Connecting the AV receiver—Continued

### Connecting an Outdoor FM Antenna

If you cannot achieve good reception with the supplied indoor FM antenna, try a commercially available outdoor FM antenna instead.

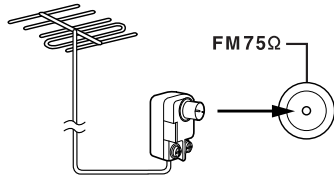

#### Notes:

- Outdoor FM antennas work best outside, but usable results can sometimes be obtained when installed in an attic or loft.
- For best results, install the outdoor FM antenna well away from tall buildings, preferably with a clear line of sight to your local FM transmitter.
- Outdoor antenna should be located away from possible noise sources, such as neon signs, busy roads, etc.
- For safety reasons, outdoor antenna should be situated well away from power lines and other high-voltage equipment.
- Outdoor antenna must be grounded in accordance with local regulations to prevent electrical shock hazards.

### ■ Using a TV/FM Antenna Splitter

It's best not to use the same antenna for both FM and TV reception, as this can cause interference problems. If circumstances demand it, use a TV/FM antenna splitter, as shown.

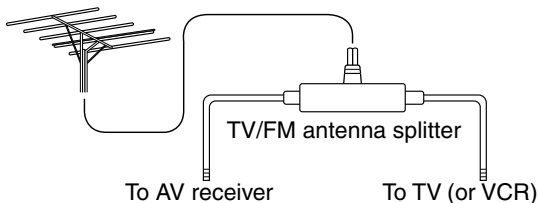

### Connecting an Outdoor AM Antenna

If good reception cannot be achieved using the supplied AM loop antenna, an outdoor AM antenna can be used in addition to the loop antenna, as shown.

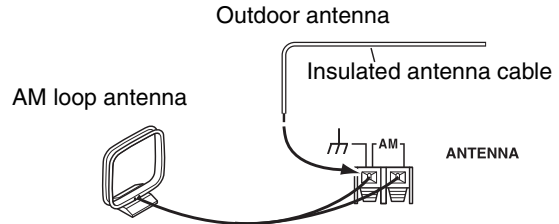

Outdoor AM antennas work best when installed horizontally outside, but good results can sometimes be obtained indoors by mounting horizontally above a window. Note that the AM loop antenna should be left connected.

Outdoor antenna must be grounded in accordance with local regulations to prevent electrical shock hazards.

## Connecting the AV receiver—Continued

### About AV Connections

- Before making any AV connections, read the manuals supplied with your other AV components.
- Don't connect the power cord until you've completed and double-checked all AV connections.

### Optical Digital Jacks

The AV receiver's optical digital jacks have shutter-type covers that open when an optical plug is inserted and close when it's removed. Push plugs in all the way.

#### Caution:

To prevent shutter damage, hold the optical plug straight when inserting and removing.

### AV Connection Color Coding

RCA-type AV connections are usually color coded: red, white, and yellow. Use red plugs to connect right-channel audio inputs and outputs (typically labeled "R"). Use white plugs to connect left-channel audio inputs and outputs (typically labeled "L"). And use yellow plugs to connect composite video inputs and outputs.



- Push plugs in all the way to make good connections (loose connections can cause noise or malfunctions).
- To prevent interference, keep audio and video cables away from power cords and speaker cables.

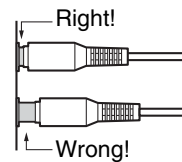

### AV Cables and Jacks

Video/Audio			
	Cable	Jack	Description
HDMI			HDMI connections can carry uncompressed standard- or high-definition digital video and audio and offer the best picture and sound quality.
Video			
	Cable	Jack	Description
Component video cable			Component video separates the luminance (Y) and color difference signals (PR, PB), providing the best picture quality. (Some TV manufacturers label their component video jacks slightly differently.)
Composite video cable			Composite video is commonly used on TVs, VCRs, and other video equipment.
Audio			
	Cable	Jack	Description
Optical digital audio cable			This offers the best sound quality and allows you to enjoy Dolby Digital and DTS. The audio quality is the same as for coaxial.
Coaxial digital audio cable			This offers the best sound quality and allows you to enjoy Dolby Digital and DTS. The audio quality is the same as for optical.
Analog audio cable (RCA)			This cable carries analog audio. It's the most common connection format for analog audio and can be found on virtually all AV components.
Stereo mini plug cable			This cable carries analog audio. Turn on the external device to playback.

**Note:** The AV receiver does not support SCART connections.

## Connecting the AV receiver—Continued

### Connecting Audio and Video Signals to the AV receiver

By connecting both the audio and video outputs of your DVD player and other AV components to the AV receiver, you can switch the audio and video signals simultaneously simply by changing the input source on the AV receiver.

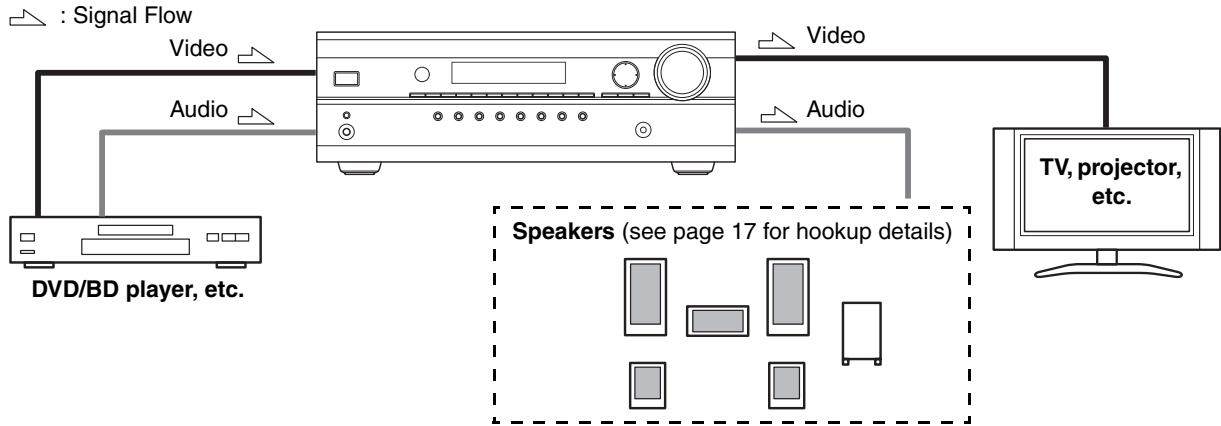

### Which Connections Should I Use?

The AV receiver supports several connection formats for compatibility with a wide range of AV equipment. The format you choose will depend on the formats supported by your other components. Use the following sections as a guide. For video components, you must make an audio connection and a video connection.

#### Video Connection Formats

Video equipment can be connected to the AV receiver by using any one of the following video connection formats: composite video, component video, or HDMI, the latter offering the best picture quality.

When choosing a connection format, bear in mind that the AV receiver doesn't convert between formats, so only outputs of the same format as the input will output the signal.

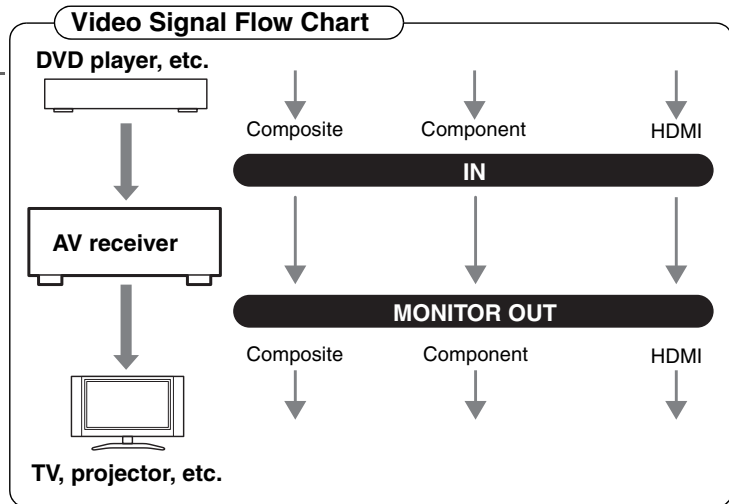

#### Audio Connection Formats

Audio equipment can be connected to the AV receiver by using any of the following audio connection formats: analog, optical, coaxial, or HDMI.

When you connect audio equipment to an OPTICAL or COAXIAL input, you must assign that input to an input selector (see page 36).

Audio signals received by the HDMI IN jacks are output only by the HDMI OUT (Pass-Thru). HDMI sources are not output by the speakers connected to the AV receiver.

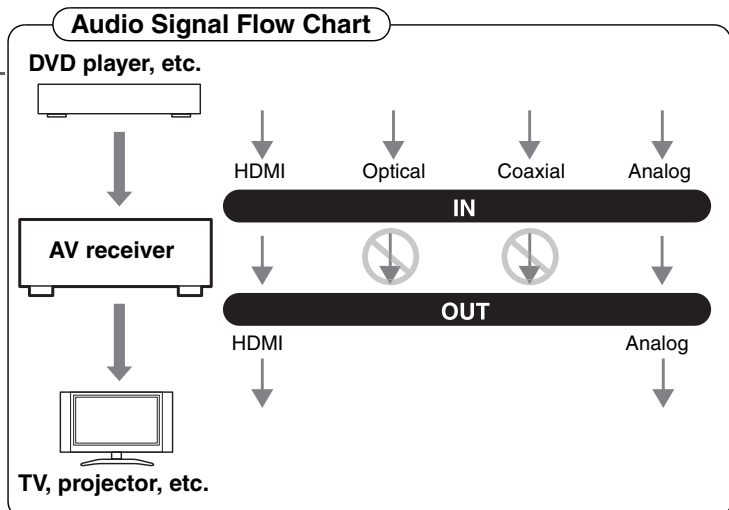

### Connecting Components with HDMI

#### About HDMI

Designed to meet the increased demands of digital TV, HDMI (High Definition Multimedia Interface) is a new digital interface standard for connecting TVs, projectors, DVD/BD players, set-top boxes, and other video components. Until now, several separate video and audio cables have been required to connect AV components. With HDMI, a single cable can carry control signals, digital video, and up to eight channels of digital audio (2-channel PCM, multichannel digital audio, or multichannel PCM).

The HDMI video stream (i.e., video signal) is compatible with DVI (Digital Visual Interface)<sup>\*1</sup>, so TVs and displays with a DVI input can be connected by using an HDMI-to-DVI adapter cable. (This may not work with some TVs and displays, resulting in no picture.)

The AV receiver uses HDCP (High-bandwidth Digital Content Protection), so only HDCP-compatible components will display a picture.

The AV receiver's HDMI interface is based on the following standard:

#### Pass-Thru

#### About Copyright Protection

The AV receiver supports HDCP (High-bandwidth Digital Content Protection)<sup>\*2</sup>, a copy-protection system for digital video signals. Other devices connected to the AV receiver via HDMI must also support HDCP.

Use a commercially available HDMI cable (supplied with some components) to connect the AV receiver's HDMI OUT to the HDMI input on your TV or projector.

\*1 DVI (Digital Visual Interface): The digital display interface standard set by the DDWG<sup>\*3</sup> in 1999.

\*2 HDCP (High-bandwidth Digital Content Protection): The video encryption technology developed by Intel for HDMI/DVI. It's designed to protect video content and requires a HDCP-compatible device to display the encrypted video.

\*3 DDWG (Digital Display Working Group): Led by Intel, Compaq, Fujitsu, Hewlett Packard, IBM, NEC, and Silicon Image, this open industry group's objective is to address the industry's requirements for a digital connectivity specification for high-performance PCs and digital displays.

## Connecting the AV receiver—Continued

### Making HDMI Connections

If you have an HDMI-compatible player, you can connect it to the AV receiver with an HDMI cable.

**Step 1: Connect your HDMI-compatible TV to the AV receiver's HDMI OUT jack.**

**Step 2: Connect your HDMI-compatible player to the AV receiver's HDMI IN 1, 2, or 3 jack.**

**Step 3: Connect your HDMI-compatible player to an analog and/or digital audio input on the AV receiver.**

#### ■ Audio Signals

- Audio and video signals received via inputs other than the HDMI IN jacks are not output by the HDMI OUT.
- Audio and video signals received via the HDMI IN jacks are output only by the HDMI OUT.
- To watch an HDMI source that's connected via the AV receiver's HDMI jacks, the AV receiver must be turned on, otherwise no HDMI signal will be output.
- If you want to listen through the speakers connected to the AV receiver, in addition to an HDMI connection, you'll also need to make a separate analog or digital audio connection.

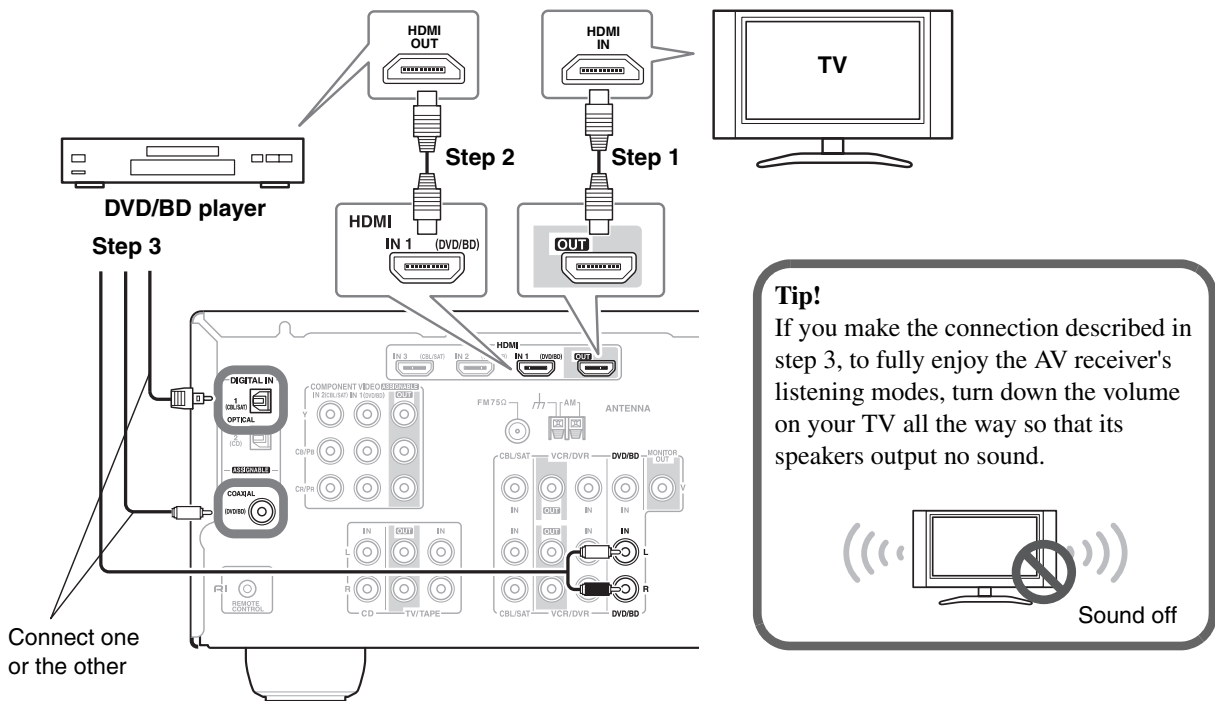

#### Notes:

- The HDMI video stream is compatible with DVI (Digital Visual Interface), so TVs and displays with a DVI input can be connected by using an HDMI-to-DVI adapter cable. (Note that DVI connections only carry video, so you'll need to make a separate connection for audio.) However, reliable operation with such an adapter is not guaranteed. In addition, video signals from a PC are not supported.
- When listening to an HDMI component through the AV receiver, set the HDMI component so that its video can be seen on the TV screen (on the TV, select the input of the HDMI component connected to the AV receiver).
- The HDMI audio signal (sampling rate, bit length, etc.) may be restricted by the connected source component. If the picture is poor or there's no sound from a component connected via HDMI, check its setup. Refer to the connected component's instruction manual for details.



## Connecting the AV receiver—Continued

### Connecting a TV or Projector

#### Step 1: Video Connection

Choose a video connection that matches your TV (**A** or **B**), and then make the connection.

#### Step 2: Audio Connection

Choose an audio connection that matches your TV (**a**, **b**, or **c**), and then make the connection.

- With connection **a**, you can listen to and record audio from your TV.
- To enjoy Dolby Digital and DTS, use connection **b** or **c**.

Connection	AV receiver	Signal flow	TV
<b>A</b>	COMPONENT VIDEO OUT	⇒	Component video input
<b>B</b>	MONITOR OUT V	⇒	Composite video input
<b>a</b>	TV/TAPE IN L/R	⇐	Analog audio L/R output
<b>b</b>	DIGITAL IN COAXIAL (DVD/BD)	⇐	Digital coaxial output
<b>c</b>	DIGITAL IN OPTICAL 1 (CBL/SAT)	⇐	Digital optical output

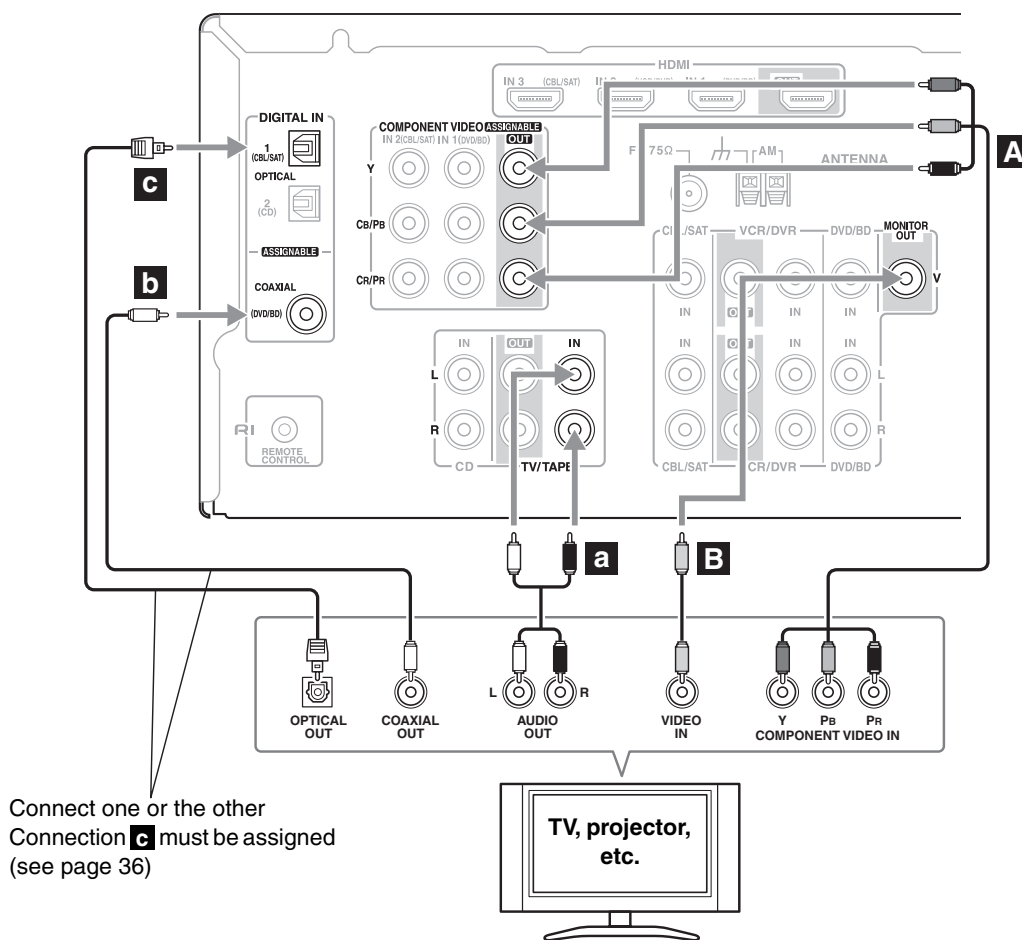

**Hint!** If your TV has no audio outputs, connect an audio output from your VCR or cable or satellite receiver to the AV receiver and use its tuner to listen to TV programs through the AV receiver (see pages 27 and 29).

# Connecting the AV receiver—Continued

## Connecting a DVD/BD player

### Step 1: Video Connection

Choose a video connection that matches your DVD/BD player (**A** or **B**), and then make the connection. You must connect the AV receiver to your TV with the same type of connection.

### Step 2: Audio Connection

Choose an audio connection that matches your DVD/BD player (**a**, **b**, or **c**), and then make the connection.

- With connection **a**, you can listen to and record audio from a DVD.
- To enjoy Dolby Digital and DTS, use connection **b** or **c**. (To record as well, use **a** and **b**, or **a** and **c**.)
- If your DVD/BD player has main left and right outputs and multichannel left and right outputs, be sure to use the main left and right outputs for connection **a**.

Connection	AV receiver	Signal flow	DVD/BD player
<b>A</b>	COMPONENT VIDEO IN 1 (DVD/BD)	←	Component video output
<b>B</b>	DVD/BD IN V	←	Composite video output
<b>a</b>	DVD/BD IN L/R	←	Analog audio L/R output
<b>b</b>	DIGITAL IN COAXIAL (DVD/BD)	←	Digital coaxial output
<b>c</b>	DIGITAL IN OPTICAL 1 (CBL/SAT)	←	Digital optical output

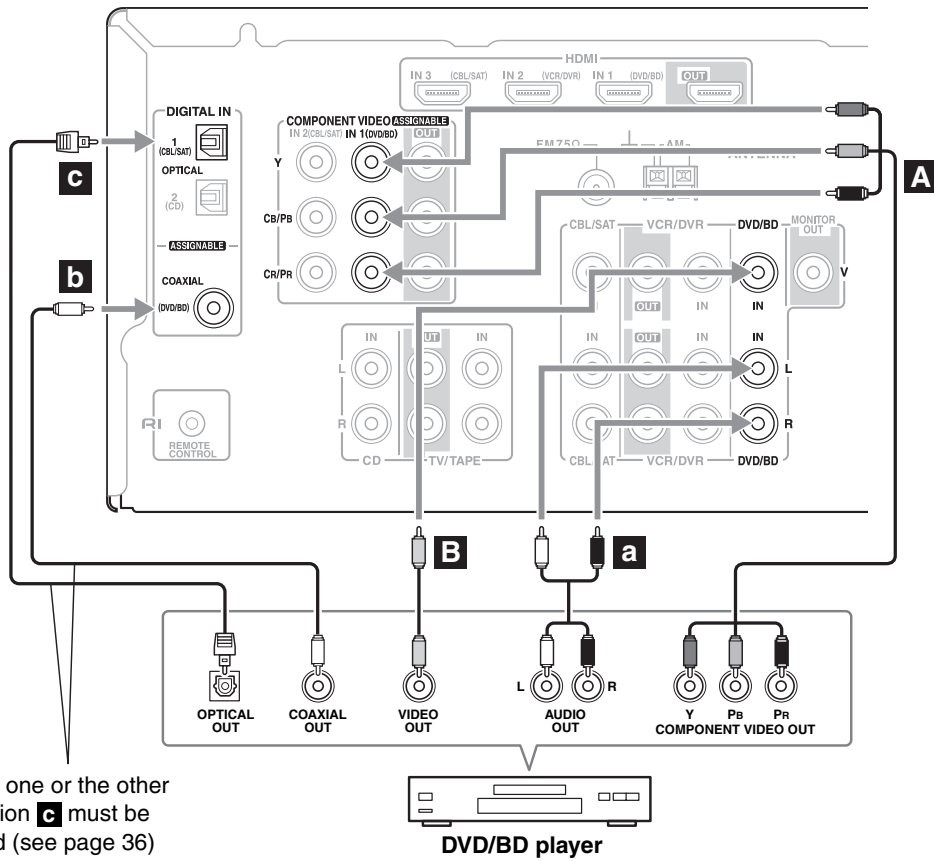

## Connecting the AV receiver—Continued

### Connecting a VCR or DVR for Playback



With this hookup, you can use the tuner in your VCR or DVR to listen to your favorite TV programs via the AV receiver, which is useful if your TV has no audio outputs.

#### Step 1: Video Connection

Choose a video connection that matches your VCR or DVR (**A** or **B**), and then make the connection. You must connect the AV receiver to your TV with the same type of connection.

#### Step 2: Audio Connection

Choose an audio connection that matches your VCR or DVR (**a**, **b**, or **c**), and then make the connection.

- To enjoy Dolby Digital and DTS, use connection **b** or **c**.

Connection	AV receiver	Signal flow	VCR or DVR
<b>A</b>	COMPONENT VIDEO IN 2 (CBL/SAT)	←	Component video output
<b>B</b>	VCR/DVR IN V	←	Composite video output
<b>a</b>	VCR/DVR IN L/R	←	Analog audio L/R output
<b>b</b>	DIGITAL IN COAXIAL (DVD/BD)	←	Digital coaxial output
<b>c</b>	DIGITAL IN OPTICAL 1 (CBL/SAT)	←	Digital optical output

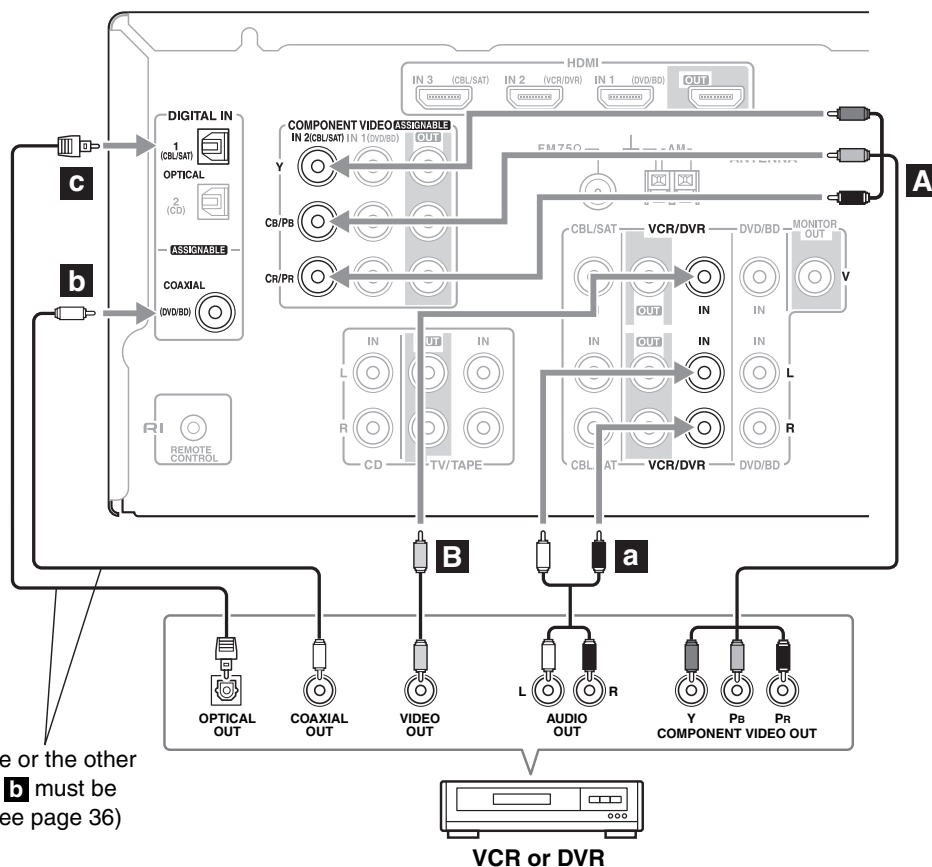

## Connecting the AV receiver—Continued

### Connecting a VCR or DVR for Recording

#### Step 1: Video Connection

Make the video connection **A**.

#### Step 2: Audio Connection

Make the audio connection **a**.

Connection	AV receiver	Signal flow	VCR or DVD recorder
<b>A</b>	VCR/DVR OUT V	⇒	Composite video input
<b>a</b>	VCR/DVR OUT L/R	⇒	Audio L/R input

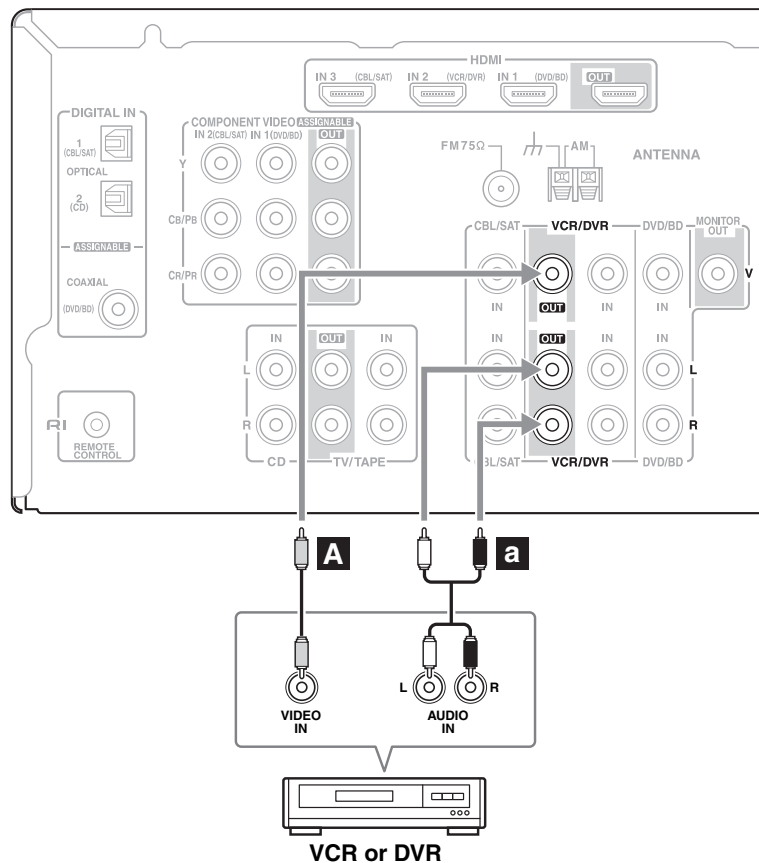

#### Notes:

- The AV receiver must be turned on for recording. Recording is not possible while it's on Standby.
- If you want to record directly from your TV or another video source without going through the AV receiver, connect the audio and video outputs from your TV or other video component directly to the recording VCR/DVR's audio and video inputs. See the manuals supplied with your TV or VCR/DVR for details.
- Video signals connected to composite video inputs can only be recorded via the VCR/DVR OUT V jack. So if your source TV or VCR is connected to a composite video input, the recording VCR/DVR must be connected to the VCR/DVR OUT V jack.

## Connecting the AV receiver—Continued

### Connecting a Satellite, Cable, Terrestrial Set-top box, or Other Video Source



With this hookup, you can use your satellite or cable receiver to listen to your favorite TV programs via the AV receiver, which is useful if your TV has no audio outputs.

#### Step 1: Video Connection

Choose a video connection that matches the video source (**A** or **B**), and then make the connection. You must connect the AV receiver to your TV with the same type of connection.

#### Step 2: Audio Connection

Choose an audio connection that matches the video source (**a**, **b**, or **c**), and then make the connection.

- With connection **a**, you can listen to and record audio from the video source.
- To enjoy Dolby Digital and DTS, use connection **b** or **c**. (To record as well, use **a** and **b**, or **a** and **c**.)

Connection	AV receiver	Signal flow	Video source
<b>A</b>	COMPONENT VIDEO IN 2 (CBL/SAT)	←	Component video output
<b>B</b>	CBL/SAT IN V	←	Composite video output
<b>a</b>	CBL/SAT IN L/R	←	Analog audio L/R output
<b>b</b>	DIGITAL IN COAXIAL (DVD/BD)	←	Digital coaxial output
<b>c</b>	DIGITAL IN OPTICAL 1 (CBL/SAT)	←	Digital optical output

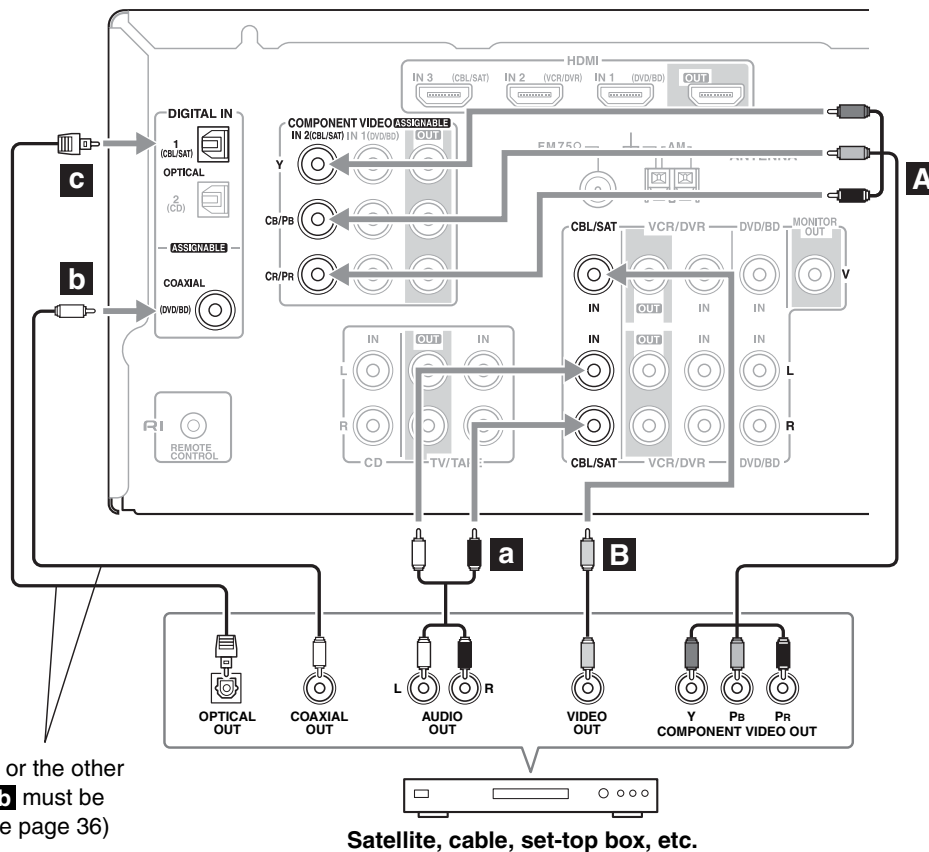

Connect one or the other  
Connection **b** must be  
assigned (see page 36)

Satellite, cable, set-top box, etc.

## Connecting the AV receiver—Continued

### Connecting a Portable Audio player

Step 1: Make the audio connection **a**.

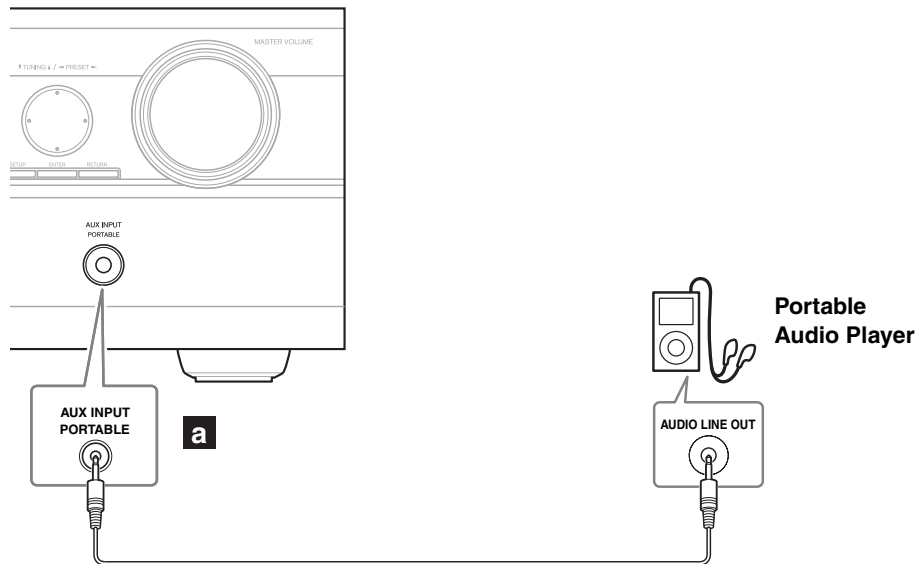

Connection	AV receiver	Signal flow	Portable Audio Player
<b>a</b>	AUX INPUT PORTABLE	←	Analog audio Line output

## Connecting the AV receiver—Continued

### Connecting a CD Player or Turntable

#### ■ CD Player or Turntable (MM) with Built-in Phono Preamp

##### Step 1:

Choose a connection that matches your CD player (**a**, **b**, or **c**). Use connection **a** for a turntable with a built-in phono preamp.

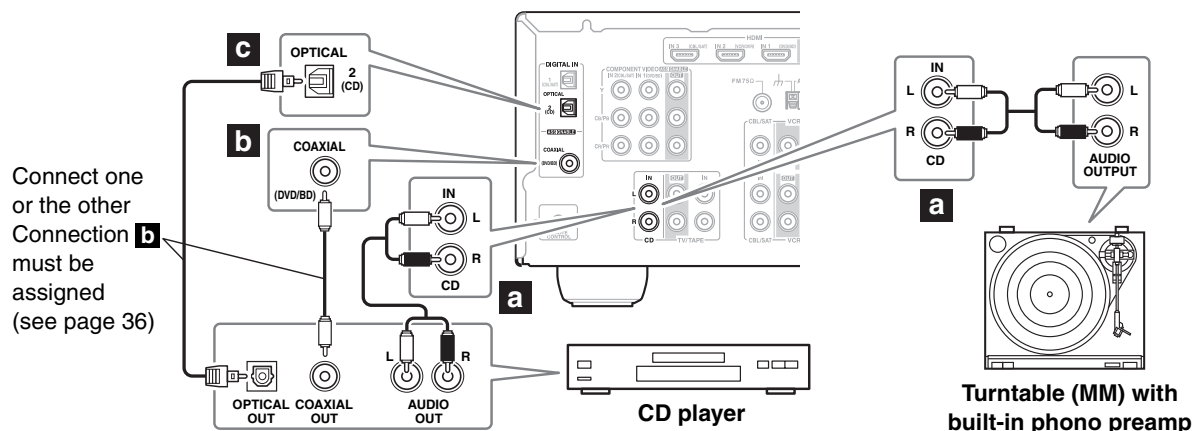

- With connection **a**, you can listen to and record audio from the CD player.
- To connect the CD player digitally, use connection **b** or **c**.

Connection	AV receiver	Signal flow	CD or turntable
<b>a</b>	CD IN L/R	←	Analog audio L/R output
<b>b</b>	DIGITAL IN COAXIAL (DVD/BD)	←	Digital coaxial output
<b>c</b>	DIGITAL IN OPTICAL 2 (CD)	←	Digital optical output

#### ■ Turntable (MM) with no Phono Preamp Built-in

A phono preamp is necessary to connect a turntable that doesn't have a phono preamp built-in.

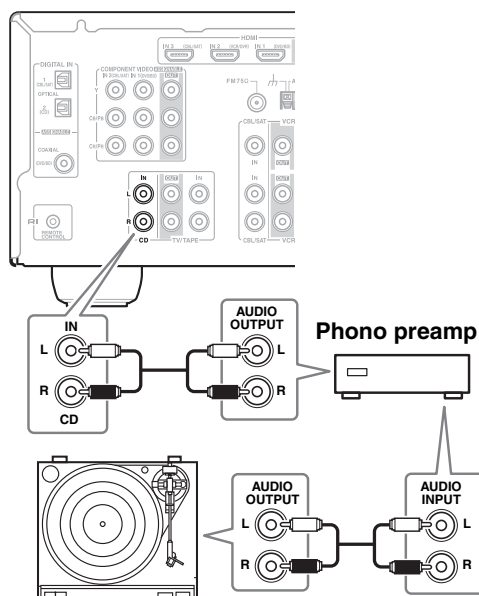

#### ■ Turntable with an MC (Moving Coil) Cartridge

An MC head amp and phono preamp are necessary to connect a turntable with an MC (Moving Coil) cartridge.

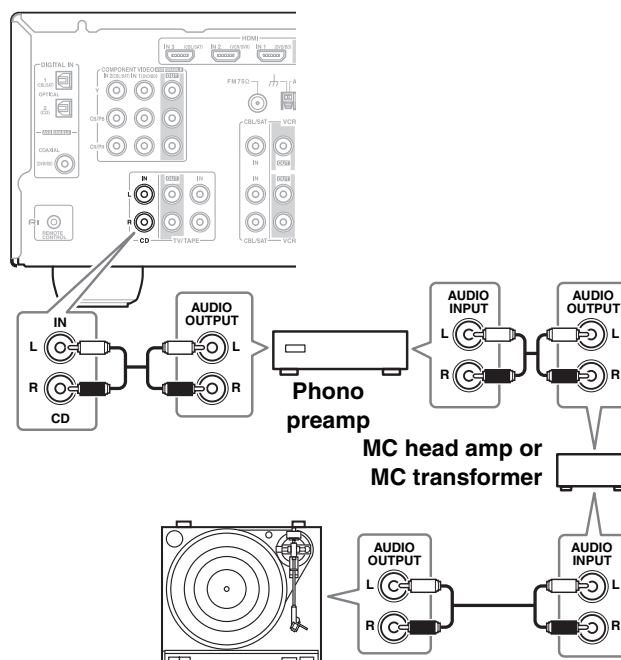

# Connecting the AV receiver—Continued

## Connecting a Cassette, CDR, MiniDisc, or DAT Recorder

### Step 1:

Choose a connection that matches your recorder (**a**, **b**, or **c**), and then make the connection.

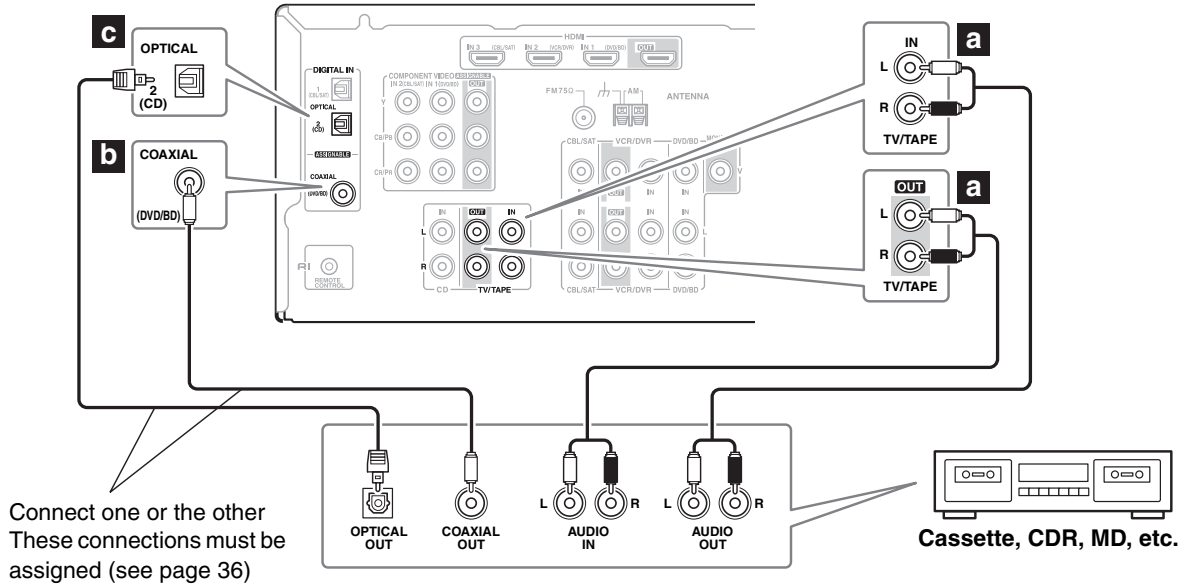

- With connection **a**, you can play and record.
- To connect the recorder digitally for playback, use connections **a** and **b**, or **a** and **c**.

Connection	AV receiver	Signal flow	Cassette, CDR, MD, or DAT recorder
<b>a</b>	TV/TAPE IN L/R TV/TAPE OUT L/R	← ⇒	Analog audio L/R output Analog audio L/R input
<b>b</b>	DIGITAL IN COAXIAL (DVD/BD)	←	Digital coaxial output
<b>c</b>	DIGITAL IN OPTICAL 2 (CD)	←	Digital optical output



## Connecting an RI Dock

Not all iPod models output video. For information about which iPod models are supported by the RI Dock, see the RI Dock's instruction manual.

### ■ If Your iPod Supports Video:

Connect your RI Dock's audio output jacks to the AV receiver's CBL/SAT IN or VCR/DVR IN L/R jacks, and connect its video output jack to the AV receiver's CBL/SAT IN or VCR/DVR IN V jack.

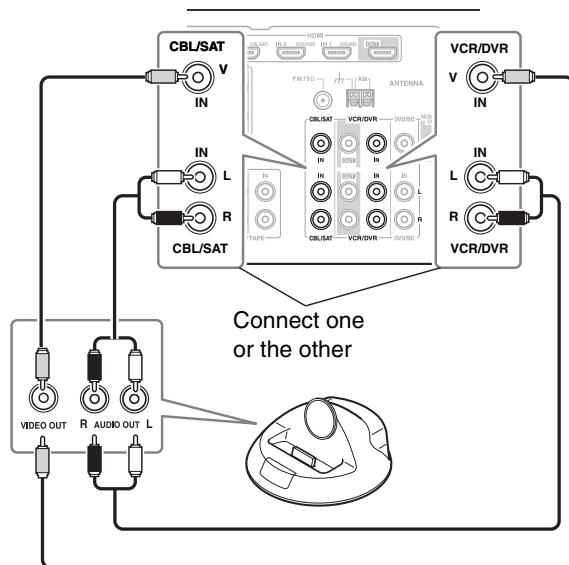

### ■ If Your iPod Doesn't Support Video:

Connect your RI Dock's audio output jacks to the AV receiver's TV/TAPE IN L/R jacks.

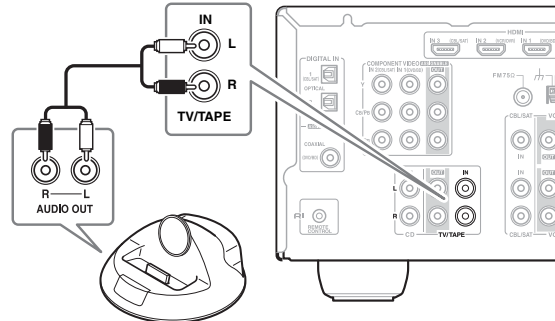

### Notes:

- Enter the appropriate remote control code before using the AV receiver's remote controller for the first time (see page 61).
- Connect the RI Dock to the AV receiver with an **RI** cable (see page 34).
- Set the RI Dock's RI MODE switch to "HDD" or "HDD/DOCK".
- Set the AV receiver's Input Display to "DOCK" (see page 37).
- See the RI Dock's instruction manual for more information.

## Connecting the AV receiver—Continued

### Connecting Onkyo **RI** Components

**Step 1:** Make sure that each Onkyo component is connected to the AV receiver with an analog audio cable (RCA).

**Step 2:** Make the necessary **RI** connections (see illustration below).

**Step 3:** If you're using an MD, CDR, or RI DOCK component, change the Input Display (see page 37).

With **RI** (Remote Interactive), you can use the following special functions:

#### ■ Auto Power On/Standby

When you start playback on a component connected via **RI**, if the AV receiver is on Standby, it will automatically turn on and select that component as the input source. Similarly, when the AV receiver is set to Standby, all components connected via **RI** will also go on Standby.

#### ■ Direct Change

When playback is started on a component connected via **RI**, the AV receiver automatically selects that component as the input source.

#### ■ Remote Control

You can use the AV receiver's remote controller to control your other **RI**-capable Onkyo components. You must enter the appropriate remote control code first (see page 61). And remember to point the remote controller at the AV receiver and not the other component.

#### Notes:

- Use only **RI** cables for **RI** connections. **RI** cables are supplied with Onkyo players (DVD, CD, etc.).
- Some components have two **RI** jacks. You can connect either one to the AV receiver. The other jack is for connecting additional **RI**-capable components.
- Connect only Onkyo components to **RI** jacks. Connecting other manufacturer's components may cause a malfunction.
- Some components may not support all **RI** functions. Refer to the manuals supplied with your other Onkyo components.

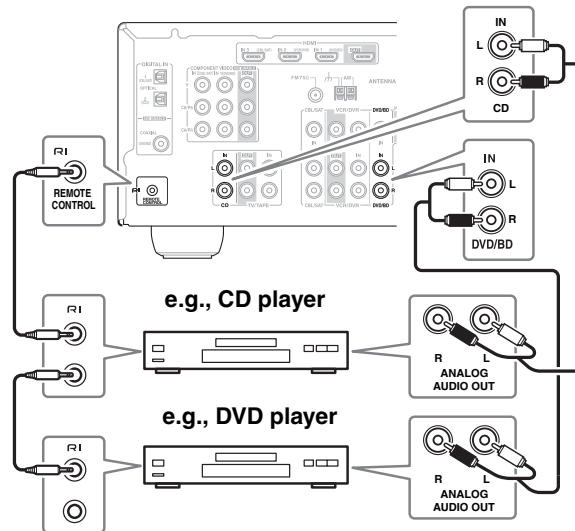

### Connecting the Power Cord

#### Notes:

- **Before connecting the power cord, connect all your speakers and AV components.**
- Plug the end of the power cord into a suitable wall outlet.
- Turning on the AV receiver may cause a momentary power surge that might interfere with other electrical equipment on the same circuit. If this is a problem, plug the AV receiver into a different branch circuit.

# Turning On the AV receiver

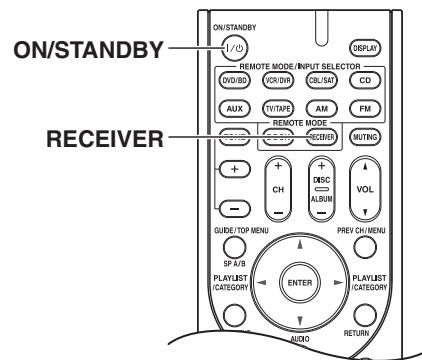
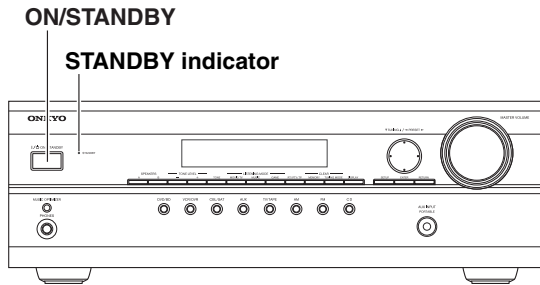

## Turning On and Standby

<p><b>AV receiver</b></p> <p>I/O ON/STANDBY</p>	<p>or</p>	<p><b>Remote controller</b></p> <p>RECEIVER ON/STANDBY</p>	<p><b>On the AV receiver, press the [ON/STANDBY] button.</b></p> <p><b>On the remote controller, press the [RECEIVER] button, followed by the [ON/STANDBY] button.</b></p> <p>The AV receiver comes on, the display lights up, and the STANDBY indicator goes off.</p> <p>To turn the AV receiver off, press the [ON/STANDBY] button, or press the remote controller's [ON/STANDBY] button. The AV receiver will enter Standby mode. To prevent any loud surprises the next time you turn on the AV receiver, turn down the volume before you turn it off.</p>
---	-----------	--	--

## Up and Running in a Few Easy Steps

To get your system up and running with the minimum of fuss, here's a few pointers to help you configure the AV receiver before you use it for the very first time. These settings only need to be made once.

■ **Did you connect a component to component video input or digital audio input?**

If you did, see "Component Video Input Setup" on page 36, or "Digital Input Setup" on page 36 respectively.

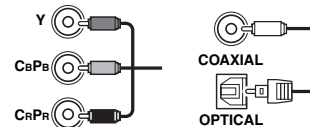

■ **Did you connect an Onkyo MD recorder, CD recorder, or RI Dock?**

If you did, see "Changing the Input Display" on page 37.

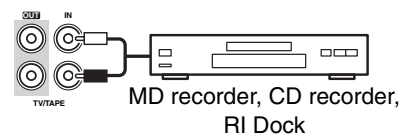

# First Time Setup

## Component Video Input Setup

If you connect to a COMPONENT VIDEO IN, you must assign it to an input selector. For example, if you connect your DVD/BD player to COMPONENT VIDEO IN 2, you should assign it to the DVD/BD input selector.

Input selector	Default assignment
DVD/BD	IN1
VCR/DVR	-----
CBL/SAT	IN2
AUX	-----
TV/TAPE	-----
CD	-----

**1** Press the [RECEIVER] button, followed by the [SETUP] button.



**2** Use the Up and Down [▲]/[▼] buttons to select "1.Component", and then press [ENTER].

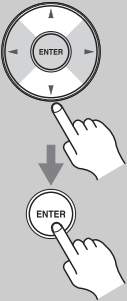

**3** Use the Up and Down [▲]/[▼] buttons to select an input selector, and use the Left and Right [◀]/[▶] buttons to select:

- IN1:** Select if the video component is connected to COMPONENT VIDEO IN 1.
- IN2:** Select if the video component is connected to COMPONENT VIDEO IN 2.
- :** Select if you're not using the COMPONENT VIDEO OUT.

**4** Press the [SETUP] button. Setup closes.



### Note:

This procedure can also be performed on the AV receiver by using its [SETUP] button, arrow buttons, and [ENTER] button.

## Digital Input Setup

To enjoy Dolby Digital and DTS, you must connect your DVD/BD player to the AV receiver by using a digital audio connection (coaxial or optical). Here are the default assignments.

Input selector	Default assignment
DVD/BD	COAX
VCR/DVR	-----
CBL/SAT	OPT1
AUX	-----
TV/TAPE	-----
CD	OPT2

With this function, you can assign digital inputs to input sources. For example, if you connect your DVD/BD player to DIGITAL IN OPTICAL 1, you'll need to assign that input (OPT1) to the DVD input source. You can change the assignments as follows.

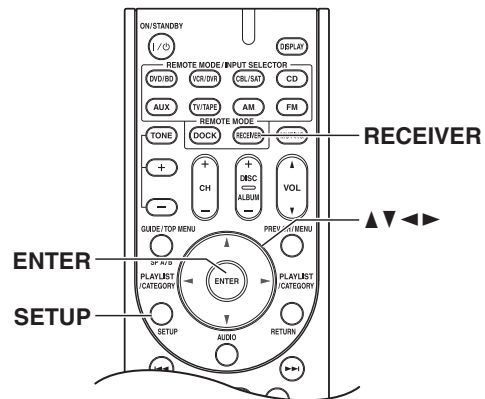

**1** Press the [RECEIVER] button, followed by the [SETUP] button.



**2** Use the Up and Down [▲]/[▼] buttons to select “2.Digital Audio”, and then press [ENTER].

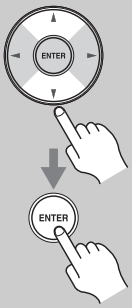

**3** Use the Up and Down [▲]/[▼] buttons to select an input selector, and then use the Left and Right [◀]/[▶] buttons to select:

**COAX:** Select if the component is connected to DIGITAL IN COAXIAL.

**OPT1:** Select if the component is connected to DIGITAL IN OPTICAL 1.

**OPT2:** Select if the component is connected to DIGITAL IN OPTICAL 2.

**-----:** Select if the component is connected to an analog input.

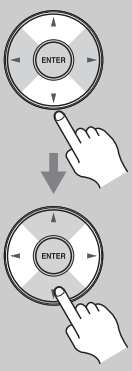

**4** Press the [SETUP] button. Setup closes.



**Notes:**

- Make sure you also set your digital sources to send out a digital signals. Please refer to the digital sources’ manual.
- This procedure can also be performed on the AV receiver by using its [SETUP] button, arrow buttons, and [ENTER] button.

**Changing the Input Display**

If you connect an **RI**-capable Onkyo MiniDisc recorder, CD recorder, or RI Dock to the TV/TAPE IN/OUT jacks, or connect an RI Dock to the CBL/SAT IN or VCR/DVR IN jacks, for **RI** to work properly, you must change this setting.

This setting can only be changed on the AV receiver.

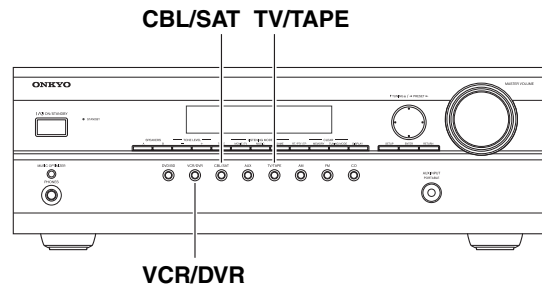

**1** Press the [TV/TAPE], [CBL/SAT] or [VCR/DVR] input selector button so that “TV/TAPE”, “CBL/SAT” or “VCR/DVR” appears on the display.



or



or



TV/TAPE

CBL/SAT

VCR/DVR

TV/TAPE

CBL/SAT

VCR/DVR

**2** Press and hold down the [TV/TAPE], [CBL/SAT] or [VCR/DVR] input selector button (about 3 seconds) to change the setting.



or



or



TV/TAPE

CBL/SAT

VCR/DVR

Repeat this step to select MD, CDR, or DOCK.

For the TV/TAPE input selector, the setting changes in this order:

TV/TAPE → MD → CDR

← DOCK ←

For the CBL/SAT input selector, the setting changes in this order:

CBL/SAT ↔ DOCK

For the VCR/DVR input selector, the setting changes in this order:

VCR/DVR ↔ DOCK

**Note:**

DOCK can be selected for the TV/TAPE or CBL/SAT or VCR/DVR input selector, but not at the same time.

# Basic Operations

## Basic AV receiver Operation

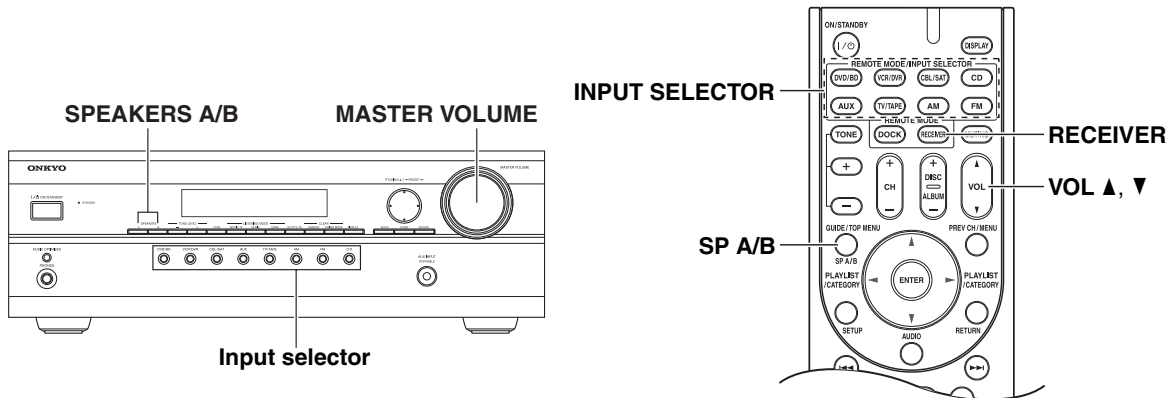

**1**

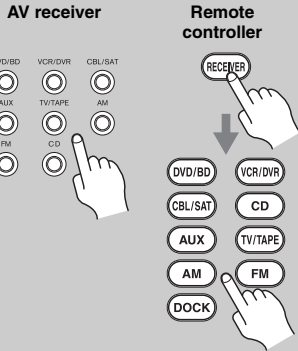

Use the AV receiver's input selector buttons to select an input source.

To select an input source with the remote controller, Press the [RECEIVER] button, and then press its INPUT SELECTOR buttons.

**2**

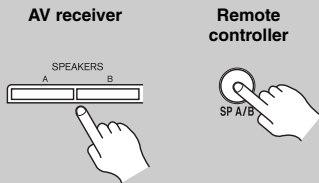

To turn the speakers on or off, use the AV receiver's SPEAKERS [A] and [B] buttons, or use the remote controller's [SP A/B] button.

Pressing the remote controller's [SP A/B] button cycles through the following settings:

Speaker Set A → Speaker Set A&B → Speaker Set B → Off

Note that while speaker set B is on, speaker set A is reduced to 2.1-channel playback.

See page 15 for more information about speaker sets A and B.

**3**

**Start playback on the source component.**

To watch a BD, DVD, or other video source, on your TV, select the video input that's connected to the AV receiver's HDMI OUT, COMPONENT VIDEO OUT, or MONITOR OUT.

On some DVD/BD players, you may need to change the digital or HDMI audio output settings.

**4**

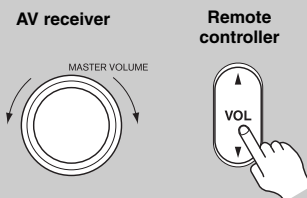

To adjust the volume, use the MASTER VOLUME control or the remote controller's VOL [▲]/[▼] button.

Since the AV receiver is designed for home theaters, it has a wide volume range for precise adjustment. The volume can be set to Min, 1 through 79, or Max.

**Note:**

The maximum master volume level is affected by the subwoofer volume level.

**5**

**Select a listening mode and enjoy!**

See "Using the Listening Modes" on page 47.

## Basic Operations—Continued

This section explains functions that can be used with any input source.

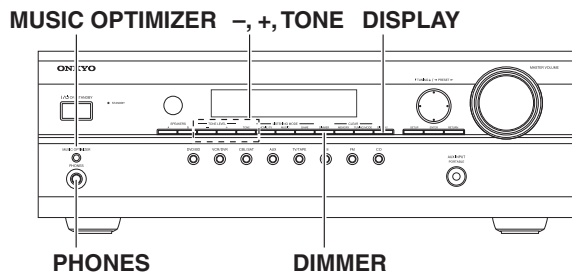
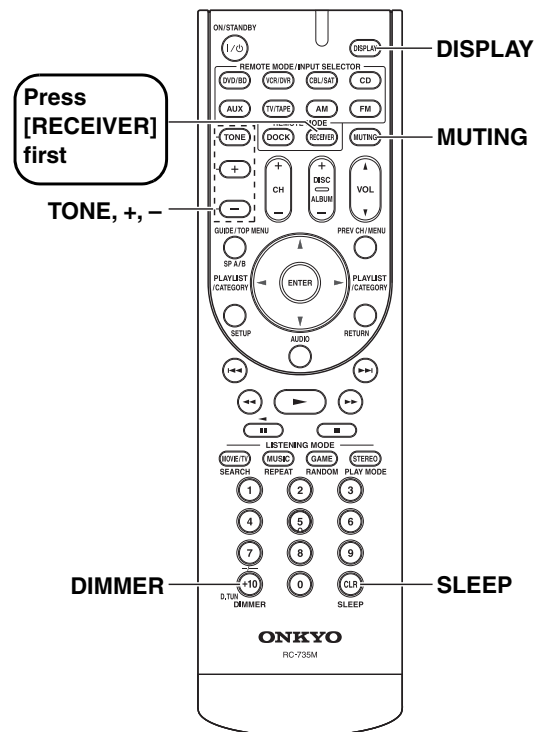

### Setting the Display Brightness

You can adjust the brightness of the display.

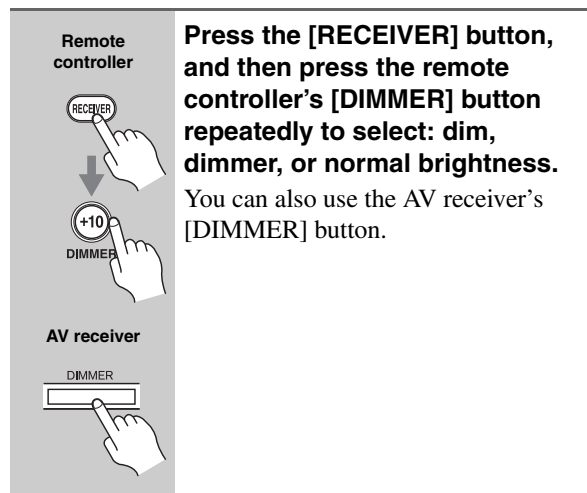

### Muting the AV receiver

You can temporarily mute the output of the AV receiver.

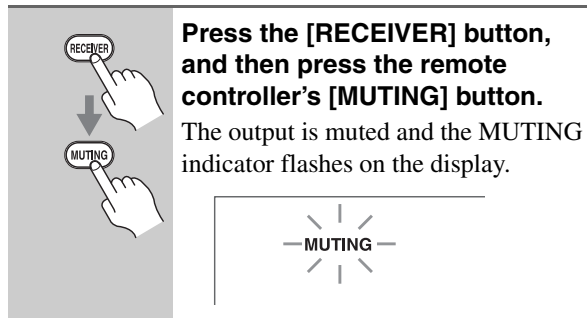

**To unmute the AV receiver,** press the remote controller's [MUTING] button again, or adjust the volume. The output is unmuted and the MUTING indicator goes off.

Muting is cancelled when the AV receiver is set to Standby.

### Using the Sleep Timer

With the sleep timer, you can set the AV receiver so that it turns off automatically after a specified period.

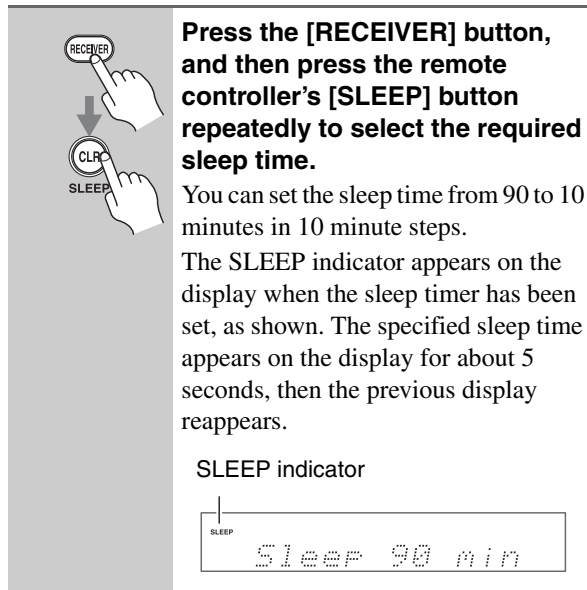

**To cancel the sleep timer,** press the [SLEEP] button repeatedly until the SLEEP indicator disappears.

**To check the remaining sleep time,** press the [SLEEP] button. Note that if you press the [SLEEP] button while the sleep time is being displayed, you'll shorten the sleep time by 10 minutes.

### Using Headphones

For private listening, you can connect a pair of stereo headphones (1/4-inch phone plug) to the AV receiver's PHONES jack.

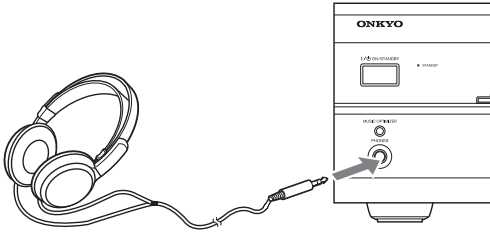

#### Notes:

- Always turn down the volume before connecting your headphones.
- While the headphones plug is inserted in the PHONES jack, the speakers are turned off.
- Speaker sets A and B are turned off while the headphones plug is inserted in the PHONES jack.
- When you connect a pair of headphones, the listening mode is set to Stereo, unless it's already set to Mono, Stereo, or Direct, in which case it stays the same.

### Adjusting the Bass & Treble

You can adjust the bass or treble for speaker set A's front speakers, except when the Direct listening mode is selected.

**Press the [TONE] button repeatedly to select either "Bass" or "Treble". Use the TONE [-]/[+] buttons to adjust.**

**Tip:** This procedure can also be performed on the remote controller by using [AUDIO] button (see page 58).

#### ■ Bass

You can boost or cut low-frequency sounds output by the front speakers from -10 dB to +10 dB in 2 dB steps.

#### ■ Treble

You can boost or cut high-frequency sounds output by the front speakers from -10 dB to +10 dB in 2 dB steps.

### Displaying Source Information

You can display various information about the current input source as follows.

**Press the [RECEIVER] button, and then press the [DISPLAY] button repeatedly to cycle through the available information.**

#### Note:

This procedure can also be performed on the AV receiver by using its [DISPLAY] button.

The following information can typically be displayed:

<b>Input source &amp; volume*1</b>	DVD/BD	48
	↓	↑
<b>Signal format*2 or sampling frequency</b>	Dolby D	3/21
	↓	↑
<b>Input source &amp; listening mode</b>	DVD Dolby D	

\*1 When AM or FM radio is used, the band, preset number, and frequency are displayed.

\*2 If the input signal is analog, or AM or FM radio is selected, no format information is displayed. If the input signal is PCM, the sampling frequency is displayed. If the input signal is digital but not PCM, the signal format is displayed. Information is displayed for about 3 seconds, then the previous display reappears.

#### Interpreting Surround Channel Information

3/21  
A B C

- A: The number of front channels (front left, front right, and center).
- B: The number of surround channels (surround left and surround right).
- C: LFE channel for subwoofer (1 means yes).



## Using the Music Optimizer

The Music Optimizer function enhances the sound quality of compressed music files. Use it with music files that use “lossy” compression, such as MP3.



	<p><b>To turn the Music Optimizer “On” or “Off”, use the AV receiver’s [MUSIC OPTIMIZER] button.</b></p> <p><b>Off:</b> Music Optimizer off (default).  <b>On:</b> Music Optimizer on.</p> <p><b>Tip:</b>          This procedure can also be performed on the remote controller by using [AUDIO] button (see page 59).</p>
---	---

**Note:**

The Music Optimizer function only works with PCM digital audio input signals with a sampling rate below 48 kHz and analog audio input signals. The Music Optimizer is disabled when the Direct listening mode is selected.

## Specifying the Digital Signal Format



The following table shows the display indicator for each digital signal format.

Format	Display
Dolby Digital	 D
DTS	
PCM	PCM

Normally, the AV receiver detects the format of digital input signals automatically. However, if you experience either of the following issues when playing PCM or DTS sources, you can specify the signal format manually.

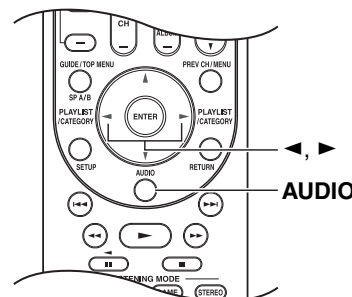
- If the beginnings of tracks from a PCM source are cut off, try the PCM setting.
- If noise is produced when fast forwarding or rewinding a DTS CD, try the DTS setting.



<p><b>1</b></p> 	<p><b>Press and hold [AUDIO] button for about 8 seconds.</b></p>
<p><b>2</b></p> 	<p><b>While “Auto” is displayed (about 3 seconds), use the Left and Right [◀]/[▶] buttons to select: PCM, DTS, or Auto.</b></p> <p><b>PCM:</b>          Only 2-channel PCM format input signals will be heard. If the input signal is not PCM, the PCM indicator will flash and there will be no sound.</p> <p><b>DTS:</b>          Only DTS format input signals will be heard. If the input signal is not DTS, the DTS indicator will flash and there will be no sound.</p> <p><b>Auto (default):</b>          The format is detected automatically. If no digital input signal is present, the corresponding analog input is used instead.</p>

# Listening to the Radio

## AM/FM Frequency Step Setup

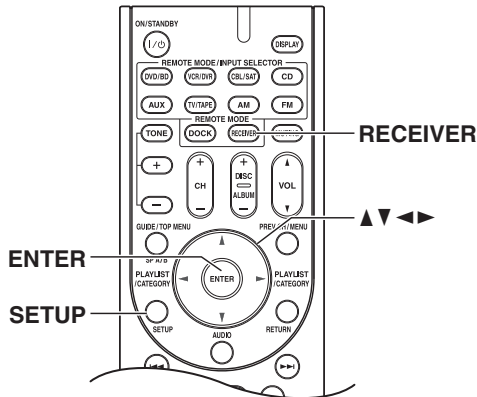

For AM/FM tuning to work properly, you must specify the AM/FM frequency step used in your area. Note that when this setting is changed, all radio presets are deleted.

**1**



**Press the [RECEIVER] button, followed by the [SETUP] button.**

**2**



**Use the Up and Down [▲]/[▼] buttons to select “8.Hardware”, and then press [ENTER].**

**3**



**Use the Up and Down [▲]/[▼] buttons to select “FM/AM” (North American/Taiwan models) or “AM Freq” (Asian models). (North American/Taiwan models)**

FM/AM # 50k/ 9k

**(Asian models)**

AM Freq # 9kHz

**4**



**Use the Left and Right [◀]/[▶] buttons to select:**

**(North American/Taiwan models)**

**200k/10k:**

Select if 200k/10k steps are used in your area.

**50k/9k:** Select if 50k/9k steps are used in your area.

**(Asian models)**

**10kHz:** Select if 10kHz steps are used in your area.

**9kHz:** Select if 9kHz steps are used in your area.

**5**



**Press the [SETUP] button.**

Setup closes.

**Note:**

This procedure can also be performed on the AV receiver by using its [SETUP] button, arrow buttons, and [ENTER] button.

## Listening to AM/FM Stations

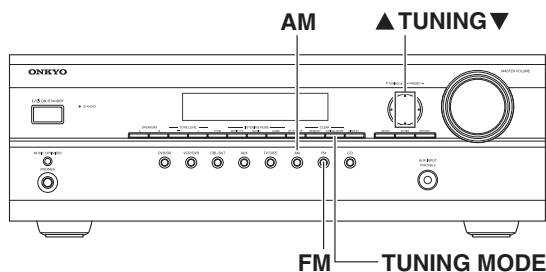

With the built-in tuner, you can enjoy AM and FM radio stations and store your favorite stations as presets for easy selection.

AM



or

FM



**Use the [AM] or [FM] input selector button to select “AM” or “FM”.**

In this example, FM has been selected.

Band	Frequency
FM	87.5 MHz

(Actual display depends on country.)

## Tuning into AM/FM Radio Stations

### Auto Tuning Mode

**1**



**Press the [TUNING MODE] button so that the AUTO indicator appears on the display.**

**2**

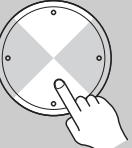

**Press the TUNING Up or Down [▲]/[▼] button.**

Searching stops when a station is found.

When tuned into a station, the TUNED indicator appears. When tuned into a stereo FM station, the FM STEREO indicator also appears.



### Manual Tuning Mode

**1**

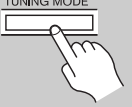

**Press the [TUNING MODE] button so that the AUTO indicator disappears from the display.**

**2**



**Press and hold the TUNING Up or Down [▲]/[▼] button.**

The frequency stops changing when you release the button.

Press the button repeatedly to change the frequency one step at a time.

The North American model changes FM frequency in 0.2MHz steps, 10kHz steps for AM. For other models it's 0.05MHz steps for FM and 9kHz (or 10kHz) steps for AM.

In Manual Tuning mode, FM stations will be in mono.

### Tuning into Weak FM Stereo Stations

If the signal from a stereo FM station is weak, it may be impossible to get good reception. In this case, switch to Manual Tuning mode and listen to the station in mono.

### Note:

You can also use the remote controller's Up and Down [▲]/[▼] buttons to tune the radio.

# Listening to the Radio—Continued

## ■ Tuning into Stations by Frequency

You can tune into AM and FM stations directly by entering the appropriate frequency.

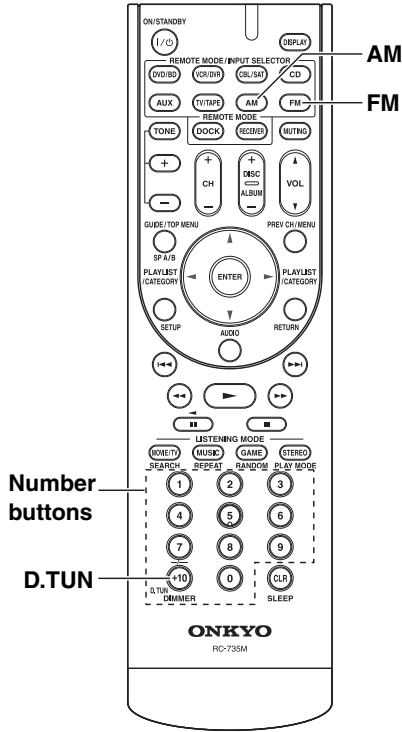

## Displaying AM/FM Radio Information

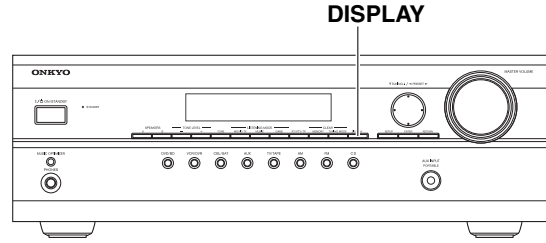

**Press the [DISPLAY] button repeatedly to cycle through the available information.**

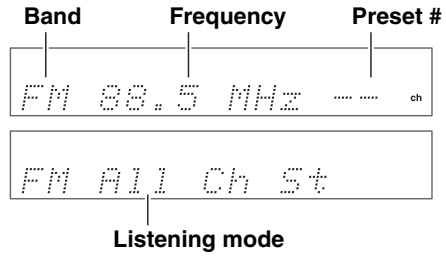

**1** Press the [AM] or [FM] button to select “AM” or “FM”, followed by the [D.TUN] button.

(Actual display depends on country.)

**2** Within 8 seconds, use the number buttons to enter the frequency of the radio station. For example, to tune to 87.5 (FM), press 8, 7, 5.

## Presetting AM/FM Stations

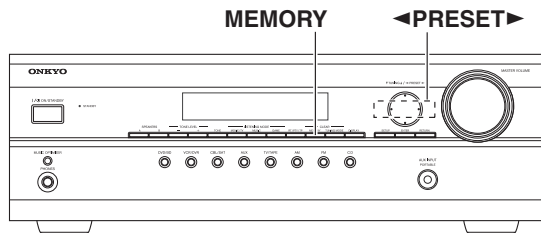

You can store a combination of up to 40 of your favorite AM and FM radio stations.

- 1** Tune into the AM or FM station you want to store as a preset.
- 2** Press the [MEMORY] button. The preset number flashes.
- 3** While the preset number is flashing (about 8 seconds), use the PRESET [◀]/[▶] buttons to select a preset from 1 through 40.
- 4** Press the [MEMORY] button again to store the station. The station is stored and the preset number stops flashing. Repeat this procedure for all of your favorite stations.

## Deleting Presets

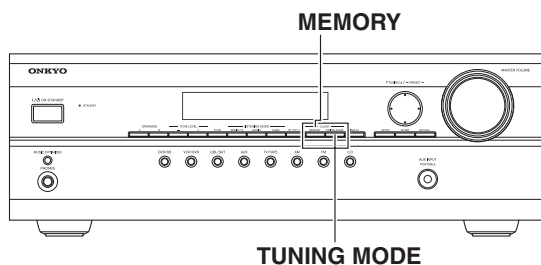

- 1** Select the preset that you want to delete. See the next section.
- 2** While holding down the [MEMORY] button, press the [TUNING MODE] button. The preset is deleted and its number disappears from the display.

## Selecting Presets

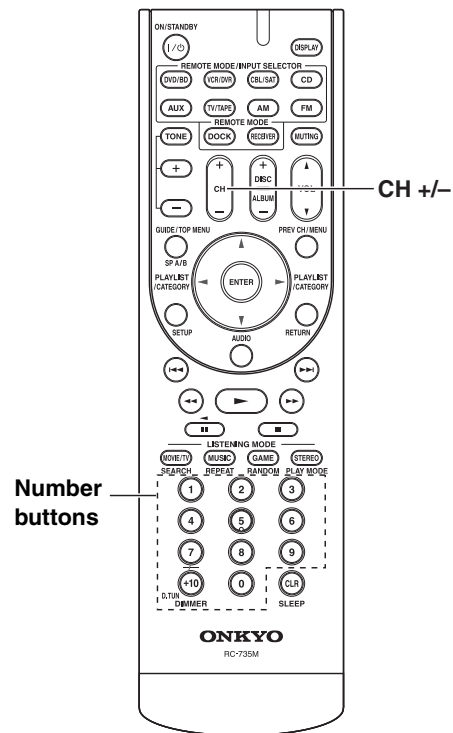
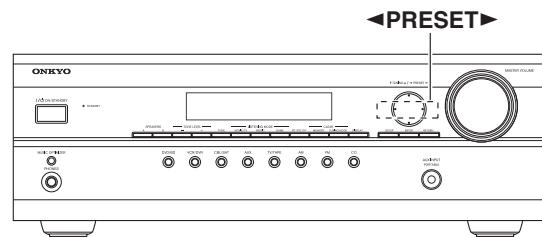

Number buttons

CH +/-

AV receiver

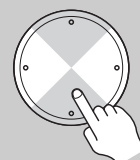

or

Remote controller



or

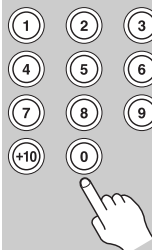

To select a preset, use the PRESET [◀]/[▶] buttons or the remote controller's CH [+/-] button.

You can also use the remote controller's number buttons to select a preset directly.

# Recording

This section explains how to record the input source and how to record audio and video from separate sources.

**Notes:**

- The surround sound and DSP listening modes cannot be recorded.
- Copy-protected DVDs cannot be recorded.
- Sources connected to a digital input cannot be recorded. Only analog inputs can be recorded.
- DTS signals will be recorded as noise, so don't attempt analog recording of DTS CDs or LDs.

## Recording the Input Source

Audio sources can be recorded to a recorder (e.g., cassette deck, CDR, MD) connected to the TV/TAPE OUT jack. Video sources can be recorded to a video recorder (e.g., VCR, DVR) connected to the VCR/DVR OUT jacks. See pages 21 to 34 for hookup information.

<b>1</b>	<p><b>Use the input selector buttons to select the source that you want to record.</b></p> <p>You can watch the source while recording it. The AV receiver's MASTER VOLUME control has no effect on recording.</p>
<b>2</b>	<p><b>On your recorder, start recording.</b></p>
<b>3</b>	<p><b>On the source component, start playback.</b></p>

**Note:**

If you select a different input source during recording, that input source will be recorded instead.

## Recording from Different AV Sources

You can overdub audio onto your video recordings by simultaneously recording audio and video from two separate sources. This is possible because only the audio source is switched when an audio-only input source, such as TV/TAPE or CD, is selected, the video source remains the same.

In the following example, audio from the CD player connected to the CD IN and video from the camcorder connected to the DVD/BD IN V jack are recorded by the VCR connected to the VCR/DVR OUT jacks.

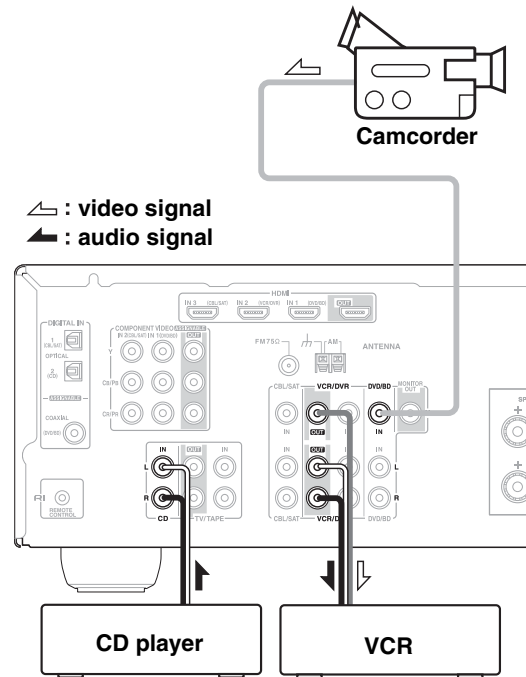

- |          |   |
|----------|---|
| <b>1</b> | <p><b>Prepare the camcorder and CD player for playback.</b></p>   |
| <b>2</b> | <p><b>Prepare the VCR for recording.</b></p>  |
| <b>3</b> | <p><b>Press the [DVD/BD] input selector button.</b></p>   |
| <b>4</b> | <p><b>Press the [CD] input selector button.</b></p> <p>This selects the CD player as the audio source but leaves the camcorder as the video source.</p>                             |
| <b>5</b> | <p><b>Start recording on the VCR, then start playback on the camcorder and CD player.</b></p> <p>Video from the camcorder and audio from the CD player are recorded by the VCR.</p> |

# Using the Listening Modes

## Selecting the Listening Modes

For a description of each listening mode, see “About the Listening Modes” on page 51.

- The Dolby Digital and DTS listening modes can only be selected if your DVD/BD player is connected to the AV receiver with a digital audio connection (OPTICAL or COAXIAL).
- The listening modes you can select depends on the format of the input signal. To check the format, see “Displaying Source Information” on page 40.
- While a pair of headphones is connected, you can only select the Mono, Direct, or Stereo listening mode.

## Selecting on the AV receiver

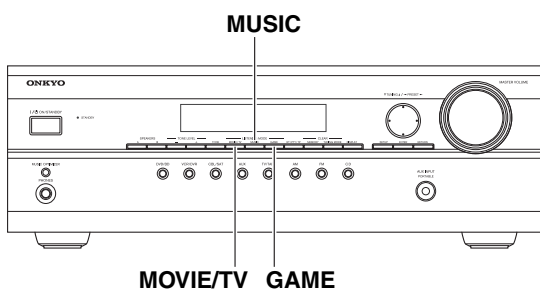

- **[MOVIE/TV] button**  
This button selects the listening modes intended for use with movies and TV.
- **[MUSIC] button**  
This button selects the listening modes intended for use with music.
- **[GAME] button**  
This button selects the listening modes intended for use with video games.

## Selecting with the Remote Controller

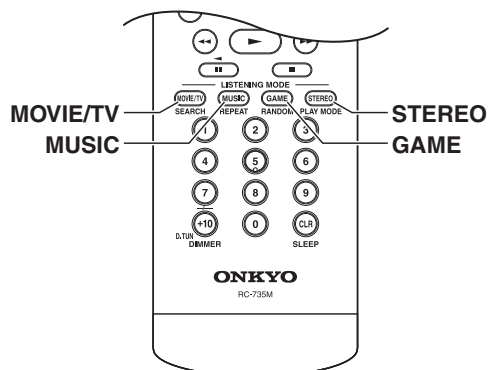

- **[MOVIE/TV] button**  
This button selects the listening modes intended for use with movies and TV.
- **[MUSIC] button**  
This button selects the listening modes intended for use with music.
- **[GAME] button**  
This button selects the listening modes intended for use with video games.
- **[STEREO] button**  
This button selects the Stereo listening mode and All Channel Stereo listening mode.

# Using the Listening Modes—Continued

## Listening Modes Available for Each Source Format

The Speaker layout illustration shows which speakers are set to active in the “Sp Config” setting (see page 52).

The LISTENING MODE button illustration shows that listening modes can be selected.

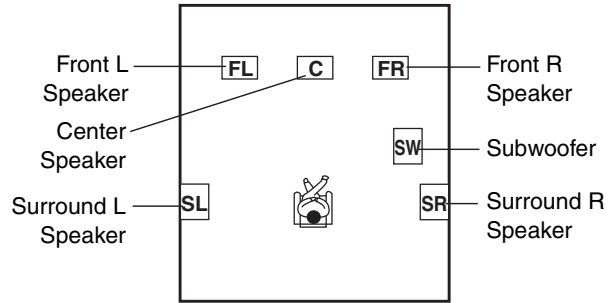

**C** : active in the “Sp Config” setting  
**C** : non-active in the “Sp Config” setting

### Mono/Multiplex Sources

✓: Available Listening Modes

Listening Mode	Button	Speaker layout		
Direct		✓	✓	✓
Stereo		✓	✓	✓
Mono		✓	✓	✓
Orchestra				✓
Unplugged				✓
Studio-Mix				✓
TV Logic				✓
Game-RPG				✓
Game-Action				✓
Game-Rock				✓
Game-Sports				✓
AllChStereo			✓	✓
FullMono			✓	✓
T-D (Theater-dimensional)		✓	✓	✓



# Using the Listening Modes—Continued

## Stereo Source



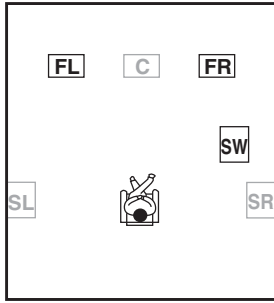
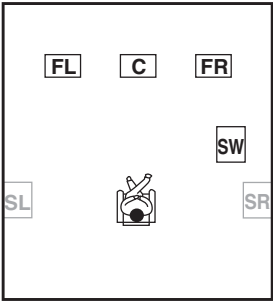
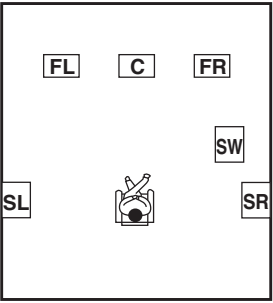







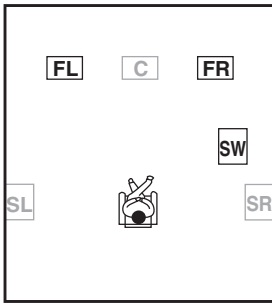
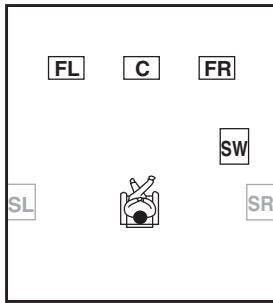
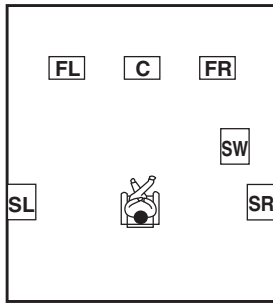















✓: Available Listening Modes

Listening Mode	Button	Speaker layout		
				
Direct		✓	✓	✓
Stereo		✓	✓	✓
Mono		✓	✓	✓
PLII Movie			✓	✓
PLII Music			✓	✓
PLII Game			✓	✓
Neo:6 Cinema			✓	✓
Neo:6 Music			✓	✓
Orchestra				✓
Unplugged				✓
Studio-Mix				✓
TV Logic				✓
Game-RPG				✓
Game-Action				✓
Game-Rock				✓
Game-Sports				✓
AllChStereo	 		✓	✓
FullMono			✓	✓
T-D (Theater-dimensional)		✓	✓	✓

## Using the Listening Modes—Continued

### Multichannel Sources

✓: Available Listening Modes

Listening Mode	Button	Speaker layout		
				
Direct	  	✓	✓	✓
Stereo	 	✓	✓	✓
Mono		✓	✓	✓
Dolby Digital/ DTS/ DTS 96/24	  		✓	✓
Orchestra				✓
Unplugged				✓
Studio-Mix				✓
TV Logic				✓
Game-RPG				✓
Game-Action				✓
Game-Rock				✓
Game-Sports				✓
AllChStereo	   		✓	✓
FullMono	  		✓	✓
T-D (Theater- dimensional)	 	✓	✓	✓

### About the Listening Modes

The AV receiver's listening modes can transform your listening room into a movie theater or concert hall, with high fidelity and stunning surround sound.

#### Direct

In this mode, audio from the input source is output directly with minimal processing, providing high-fidelity reproduction. All of the source's audio channels are output as they are.

#### Stereo

Sound is output by the front left and right speakers and subwoofer.

#### Mono

Use this mode when watching an old movie with a mono soundtrack, or use it with the foreign language soundtracks recorded in the left and right channels of some movies. It can also be used with DVDs or other sources containing multiplexed audio, such as karaoke DVDs.

#### Dolby Pro Logic II

- **Dolby Pro Logic II Movie**

Use this mode with DVDs and videos that bear the Dolby Surround logo or TV shows that feature Dolby Surround. You can also use this mode with stereo movies or TV shows and the AV receiver will create a 5.1 surround mix from the 2-channel stereo.

- **Dolby Pro Logic II Music**

Use this mode to add 5.1 surround to stereo sources such as music CDs and DVDs.

- **Dolby Pro Logic II Game**

Use this mode when playing game discs.

#### Dolby Digital

Use this mode with DVDs that bear the Dolby Digital logo, and Dolby Digital TV broadcasts. This is the most common digital surround-sound format, and it'll put you right in the middle of the action, just like being in a movie theater or concert hall.

#### DTS

The DTS digital surround-sound format supports up to 5.1 discrete channels and uses less compression for high-fidelity reproduction. Use it with DVDs and CDs that bear the DTS logo.

#### DTS 96/24

This mode is for use with DTS 96/24 sources. This is high-resolution DTS with a 96kHz sampling rate and 24-bit resolution, providing superior fidelity. Use it with DVDs that bear the DTS 96/24 logo.

#### DTS Neo:6

This mode expands any 2-channel source for up to 5.1-channel playback. It uses five full-bandwidth channels of matrix decoding for matrix-encoded material, providing a very natural and seamless surround sound experience that fully envelops the listener.

- **Neo:6 Cinema**

Use this mode with any stereo movie (e.g., TV, DVD, VHS).

- **Neo:6 Music**

Use this mode with any stereo music source (e.g., CD, radio, cassette, TV, VHS, DVD).

### Onkyo Original DSP Modes

---

#### Orchestra

Suitable for classical or operatic music, this mode emphasizes the surround channels in order to widen the stereo image and simulates the natural reverberation of a large hall.

#### Unplugged

Suitable for acoustic instruments, vocals, and jazz, this mode emphasizes the front stereo image, giving the impression of being right in front of the stage.

#### Studio-Mix

Suitable for rock or pop music, listening to music in this mode creates a lively sound field with a powerful acoustic image, like being at a club or rock concert.

#### TV Logic

This mode adds realistic acoustics to TV shows produced in a TV studio, surround effects to the entire sound, and clarity to voices.

#### Game-RPG

Use this mode when playing role playing game discs.

#### Game-Action

Use this mode when playing action game discs.

#### Game-Rock

Use this mode when playing rock game discs.

#### Game-Sports

Use this mode when playing sports game discs.

#### All Ch Stereo

Ideal for background music, this mode fills the entire listening area with stereo sound from the front and surround speakers.

#### Full Mono

In this mode, all speakers output the same sound in mono, so the sound you hear is the same regardless of where you are within the listening room.

#### T-D (Theater-Dimensional)

With this mode you can enjoy a virtual 5.1 surround sound even with only two or three speakers. This works by controlling how sounds reach the listener's left and right ears. Good results may not be possible if there's too much reverb, so we recommend that you use this mode in an environment with little or no natural reverb.

# Advanced Setup

## Common Procedures in Setup Menu

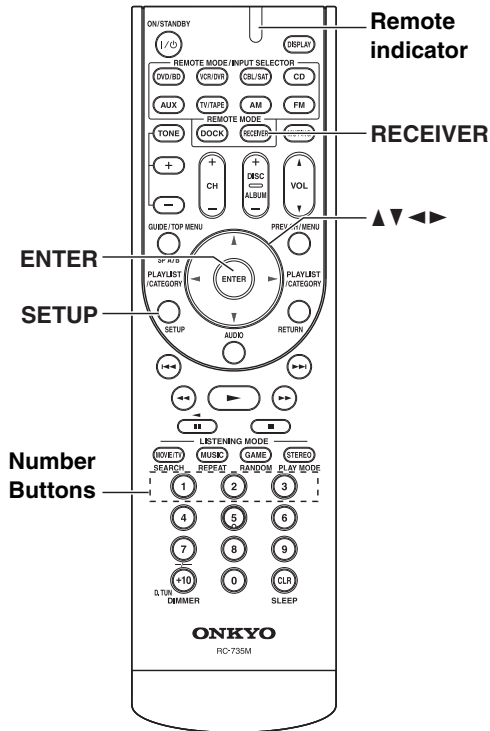

- 1** Press the [RECEIVER] button followed by the [SETUP] button.
- 2** Use the Up and Down [▲]/[▼] buttons to select the function, and then press the [ENTER] button.
- 3** Use the Up and Down [▲]/[▼] button to select item, and then use the Left and Right [◀]/[▶] buttons to set them.
- 4** When you've finished, press the [SETUP] button. Setup closes.

**Note:**  
This procedure can also be performed on the AV receiver by using its [SETUP] button, arrow buttons, and [ENTER] button.

## Speaker Settings

This section explains how to check the speaker settings and how to set them manually.

### 3. Sp Config (Speaker Configuration)

This section explains how to specify which speakers are connected and their sizes. For speakers with a cone diameter larger than 6-1/2 inches (16 cm), specify **Large** (full band). For those with a smaller diameter, specify **Small** (default crossover 120Hz). The crossover frequency can be changed on page 53.

**Note:**

Speaker Configuration, Crossover Frequency, and Double Bass settings only need to be changed if you're not using the speakers in this package. These settings cannot be changed while headphones are connected, or speaker set B is on.

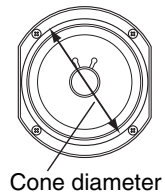

<b>Subwoofer</b>	<b>Yes:</b> Select if a subwoofer is connected (default). <b>No:</b> Select if no subwoofer is connected.
<b>Front</b> <sup>*1</sup>	<b>Small:</b> Select if the front speakers are small (default). <b>Large:</b> Select if the front speakers are large.
<b>Center</b> <sup>*2</sup>	<b>Small:</b> Select if the center speaker is small (default). <b>Large:</b> Select if the center speaker is large. <b>None:</b> Select if no center speaker is connected.
<b>Surround</b> <sup>*2</sup>	<b>Small:</b> Select if the surround speakers are small (default). <b>Large:</b> Select if the surround speakers are large. <b>None:</b> Select if no surround speakers are connected.

<sup>\*1</sup> If the "Subwoofer" setting is set to "No", this setting is fixed at "Large" and does not appear.  
<sup>\*2</sup> If the "Front" setting is set to "Small", the "Large" option cannot be selected.

### Crossover (Crossover Frequency)

This setting only applies to the speakers that you specified as “*Small*” in the “3. Sp Config” on page 52.

To get the best bass performance from your speaker system, you need to set the crossover frequency according to the size and frequency response of your speakers.

Use the diameter of the smallest speaker in your system when choosing the crossover frequency.

Speaker cone diameter	Crossover frequency
Over 8 in. (20 cm)	40/50/60Hz*
6-1/2 to 8 in. (16–20 cm)	80Hz
5-1/4 to 6-1/2 in. (13–16 cm)	100Hz
3-1/2 to 5-1/4 in. (9–13 cm)	120Hz (default)
Under 3-1/2 in. (9 cm)	150/200Hz*

\* Choose the setting suitable for the speaker.

### Notes:

- For a more accurate setting, look up the frequency response in the manuals supplied with your speakers and set accordingly.
- Choose a higher crossover frequency if you want more sound from your subwoofer.

### Double Bass

With the Double Bass function, you can boost bass output by feeding bass sounds from the front left, right, and center to the subwoofer. This function can be set only if the “Subwoofer” setting is set to “Yes”, and the “Front” setting is set to “Large” in the “3. Sp Config” on page 52.

**On:** Double Bass function on. Bass from the front left and right channels is also fed to the subwoofer (default).

**Off:** Double Bass function off.

## 4. Sp Distance (Speaker Distance)

With these settings, you can specify the distance from each speaker to the listening position.

Measure and make a note of the distance from each speaker to the listening position.

### Notes:

- Speakers that you set to “No” or “None” in the “3. Sp Config” (page 52) cannot be selected.
- The speaker distance setting cannot be changed while a pair of headphones is connected, or speaker set B is on.
- The Center and Subwoofer distances can be set up to 5 ft. (1.5 m) more or less than the Left distance. For example, if the Left distance is set to 20 ft. (6 m), the Center and Subwoofer distances can be set between 15 and 25 ft. (4.5 and 7.5 m).
- The Surround distances can be set up to 5 ft. (1.5 m) more or 15 ft. (4.5 m) less than the Left distance. For example, if the Left distance is set to 20 ft. (6 m), the SurrRight and SurrLeft distances can be set between 5 and 25 ft. (1.5 and 7.5 m).

**Unit**                    **feet:** Distances can be set in feet. Range: 1 to 30 feet in 1-foot steps.

**meters:** Distances can be set in meters. Range: 0.3 to 9 meters in 0.3-meter steps.

### Front, Center, SurrRight, SurrLeft, Subwoofer

Specify the distance from the each speaker to your listening position.

### 5. Level Cal (Speaker Levels Calibration)

You can set the volume level of each speaker so that all speakers can be heard equally at the listening position. A pink noise test tone is output by the front left speaker.

**Notes:**

- Speakers that you set to “No” or “None” in the “3. Sp Config” (page 52) do not output the test tone.
- The speaker levels cannot be adjusted while a pair of headphones is connected, speaker set B is on, or the AV receiver is muted.

---

#### **Left, Center, Right, SurrRight, SurrLeft, Subwoofer**

The levels can be adjusted from –12 to +12 dB in 1 dB steps (–15 to +12 dB for the subwoofer).

---

### 6. Equalizer (Equalizer Settings)

Here you can adjust the tone of individual speakers. To set the volume of individual speakers, see page 54.

**Notes:**

- While the Direct listening mode is selected, the equalizer settings have no effect.
- The equalizer setting cannot be changed while a pair of headphones is connected, or speaker set B is on.

---

**EQ**      **Audyssey:** Listening environment is equalized by Audyssey EQ™. “Dynamic EQ” and “Dyn Vol” become available (page 56).

**Off:** Tone off, No equalizing apply (default).

### Audio Adjust Settings

With the Audio Adjust functions and settings, you can adjust the sound and listening modes as you like.

#### 7. Audio Adjust

---

##### Multiplex/Mono Settings

---

**Input (Mux)**      **Main:** The main channel is output (default).  
                         **Sub:** The sub channel is output.  
                         **M/S:** Both the main and sub channels are output.

This setting determines which channel of a stereo multiplex source is output. Use it to select audio channels or languages with multiplex sources, multilingual TV broadcasts, and so on.

---

**Input (Mono)**      **L+R:** Both the left and right channels are output (default).  
                         **L:** Only the left channel is output.  
                         **R:** Only the right channel is output.

This setting determines which channel is output when the Mono listening mode is used with a stereo source.

---

##### PLII/Neo:6 Settings

---

These settings apply to only 2-channel stereo sources.

---

**Panorama**          **On:** Panorama function on.  
                         **Off:** Panorama function off (default).

With this setting, you can broaden the width of the front stereo image when using the Dolby Pro Logic II Music listening mode.

---

**Dimension**          **-3 to +3 (default: 0)**

With this setting, you can move the sound field forward or backward when using the Dolby Pro Logic II Music listening mode. Higher settings move the sound field backward. Lower settings move it forward.

If the stereo image feels too wide, or there's too much surround sound, move the sound field forward to improve the balance. Conversely, if the stereo image feels like it's in mono, or there's not enough surround sound, move it backward.

---

**Center Width**      **0 to 7 (default: 3)**

With this setting, you can adjust the width of the sound from the center speaker when using the Dolby Pro Logic II Music listening mode. Normally, if you're using a center speaker, the center channel sound is output by only the center speaker. (If you're not using a center speaker, the center channel sound will be distributed to the front left and right speakers to create a phantom center.) This setting controls the front left, right, and center mix, allowing you to adjust the weight of the center channel sound.

---

**Center Image**      **0 to 5 (default: 2)**

The DTS Neo:6 Music listening mode creates 6-channel surround sound from 2-channel stereo sources. With this setting, you can specify by how much the front left and right channel output is attenuated in order to create the center channel.

Setting a value [0] in the middle is set to hear a sound. Sound is spread in left and right (the outside) so that the set value is made big. Please adjust by liking.

### Audyssey Settings

Audyssey EQ™ is based on the same core technology as Audyssey MultEQ® that is used for automatic correction of room acoustics. Audyssey EQ uses time-domain filters to correct problems that arise from speaker drivers and enclosures and is calibrated to account for the acoustical problems in a typical listening environment. The Audyssey EQ filters in the HT-R370 are specifically optimized for the Onkyo HTP-370 Speaker Package and should not be used with other speakers.

---

**Dynamic EQ**      **Off:** Audyssey Dynamic EQ™ off (default).  
                         **On:** Audyssey Dynamic EQ on.

With Audyssey Dynamic EQ, you can enjoy great sound even when listening at low volume levels. Audyssey Dynamic EQ solves the problem of deteriorating sound quality as volume is decreased by taking into account human perception and room acoustics. It does so by selecting the correct frequency response and surround volume levels moment-by-moment so that the content sounds the way it was created at any volume level--not just at reference level.

**Notes:**

- Audyssey Dynamic EQ allows you to maintain the proper octave-to-octave balance at any volume level in accordance with the preset speakers.
- In order to record with appropriate sound, Audyssey EQ is automatically deactivated during a recording. After the recording is finished, Audyssey EQ and Audyssey Dynamic EQ will resume as previously set.
- Audyssey Dynamic EQ can be set only when the “6. Equalizer” on page 54 are set to “Audyssey”.
- In “Off”, “Dyn Vol” becomes “Off”.

---

### Dyn Vol (Dynamic Volume)

**Off:** Audyssey Dynamic Volume™ off.  
**Light:** Light Compression Mode becomes active.  
**Medium:** Medium Compression Mode becomes active.  
**Heavy:** Heavy Compression Mode becomes active. This setting affects volume the most, causing all sounds to be of equal loudness.

**Notes:**

- Other than “Off”, “Dynamic EQ” becomes “On”, and “6. Equalizer” (page 54) setting becomes “Audyssey”.
- “Dynamic Volume” becomes active when Dynamic EQ is set to “On”. Therefore, it is “Off” forcibly if “Dynamic EQ” becomes “Off”.

If Audyssey Dynamic EQ is set to “On”, Audyssey Dynamic Volume becomes available.

#### About Audyssey Dynamic EQ

Audyssey Dynamic EQ solves the problem of deteriorating sound quality as volume is decreased by taking into account human perception and room acoustics. Dynamic EQ selects the correct frequency response moment-by-moment at any user-selected volume setting. The result is bass response and tonal balance that remains constant despite changes in volume. Dynamic EQ combines information from incoming source levels with actual output sound levels in the room, a prerequisite for delivering a loudness correction solution. Audyssey Dynamic EQ works in tandem with Audyssey EQ to provide well-balanced sound for every listener at any volume level.

#### About Audyssey Dynamic Volume

Audyssey Dynamic Volume solves the problem of large variations in volume level between television programs, commercials, and between the soft and loud passages of movies. Dynamic Volume looks at the preferred volume setting by the user and then monitors how the volume of program material is being perceived by listeners in real time to decide whether an adjustment is needed. Whenever necessary, Dynamic Volume makes the necessary rapid or gradual adjustments to maintain the desired playback volume level while optimizing the dynamic range. Audyssey Dynamic EQ is integrated into Dynamic Volume so that as the playback volume is adjusted automatically, the perceived bass response, tonal balance, surround impression, and dialog clarity remain the same whether watching movies, flipping between television channels, or changing from stereo to surround sound content.



### T-D (Theater-Dimensional) Setting

#### LstnAngl (Listening Angle)

**Wide:** Select if the listening angle is 40 degrees (default).

**Narrow:** Select if the listening angle is 20 degrees.

With this setting, you can optimize the Theater- Dimensional listening mode by specifying the angle of the front left and right speakers relative to the listening position. Ideally, the front left and right speakers should be equidistant from the listening position and at an angle close to one of the two available settings.

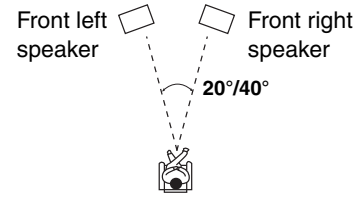

## Hardware Setup

This section explains items on the Hardware menu.

### 8. Hardware

#### Remote ID

When several Onkyo components are used in the same room, their remote ID codes may overlap. To differentiate the AV receiver from the other components, you can change its remote ID from 1, the default, to 2 or 3.

**Remote ID** 1, 2, 3

**Note:**

If you do change the AV receiver's remote ID, be sure to change the remote controller to the same ID (see below), otherwise, you won't be able to control it with the remote controller.

#### Changing the Remote Controller's ID

- 1** While holding down the [RECEIVER] button, press and hold down the [SETUP] button until the Remote indicator lights up (about 3 seconds).
- 2** Use the number buttons to enter ID 1, 2, or 3.  
The Remote indicator flashes twice.

#### Tuner

##### FM/AM (North American/Taiwan models)

See "AM/FM Frequency Step Setup" on page 42.

##### AM Freq (Asian model)

See "AM/FM Frequency Step Setup" on page 42.

## Using the Audio Settings

You can change various audio settings by pressing the [AUDIO] button.

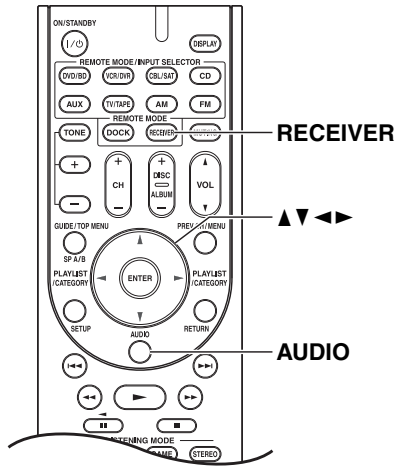

- 1** Press the [RECEIVER] button followed by the [AUDIO] button.
- 2** Use the Up and Down [▲]/[▼] buttons to select an item.
- 3** Use the Left and Right [◀]/[▶] buttons to change the setting.  
Repeat this step for the other settings.

### Tone Control Settings

You can adjust the bass and treble for the front speakers, except when the Direct listening mode is selected.

**Notes:**

- To bypass the bass and treble tone circuits, select the Direct listening mode.
- This procedure can also be performed on the AV receiver by using its [TONE], [-], and [+] buttons.

<b>Bass</b>	<b>-10dB to +10dB in 2dB steps (default: 0dB)</b>
<b>Treble</b>	<b>-10dB to +10dB in 2dB steps (default: 0dB)</b>

### Late Night Function

With the Late Night function, you can reduce the dynamic range of Dolby Digital material so that you can still hear quiet parts even when listening at low volume levels—ideal for watching movies late at night when you don't want to disturb anyone.

**Notes:**

- The Late Night function can be used only when the input source is Dolby Digital.
- The effect of the Late Night function depends on the material that you are playing and the intention of the original sound designer, and with some material there will be little or no effect when you select the different options.
- The Late Night function is set to Off when the AV receiver is set to Standby.

<b>Late Night</b>	<b>Off:</b> Late Night function off (default).
	<b>Low:</b> Small reduction in dynamic range.
	<b>High:</b> Large reduction in dynamic range.

### CinemaFILTER

With the CinemaFILTER, you can soften overly bright movie soundtracks, which are typically mixed for reproduction in a movie theater.

CinemaFILTER can be used with the following listening modes: Dolby Digital, Dolby Pro Logic II Movie, DTS, DTS 96/24, and Neo:6.

**Note:**

The CinemaFILTER may not work when used with certain input sources.

<b>Cinema Fltr</b>	<b>Off:</b> CinemaFILTER off (default).
	<b>On:</b> CinemaFILTER on.

---

### Audyssey Dynamic Volume™

**Dyn Vol** See “Dyn Vol (Dynamic Volume)” of “Audio Adjust Settings” on page 56.

---

### EX.BASS

EX.BASS is a technology that have developed by experiments and listening tests to reproduce a natural deeper bass. When you turn the mode on, you can get dynamic and deeper presence on your movies and music.

---

**EX.BASS**      **Off:** EX.BASS off.  
                    **On:** EX.BASS on (default).

---

### Music Optimizer

The Music Optimizer function enhances the sound quality of compressed music files. Use it with music files that use “lossy” compression, such as MP3.

**Note:**

The Music Optimizer function only works with PCM digital audio input signals with a sampling rate below 48kHz and analog audio input signals. The Music Optimizer is disabled when the Direct listening mode is selected.

---

**M.Optimizer**      **Off:** Music Optimizer off (default).  
                            **On:** Music Optimizer on.

---

### Speaker Levels

You can adjust the volume of each speaker while listening to an input source. These temporary adjustments are cancelled when the AV receiver is set to Standby.

**Notes:**

- You cannot use this function while the AV receiver is muted.
  - Speakers that are set to “No” or “None” in the “3. Sp Config” cannot be adjusted (see page 52).
- 

**SW Level (Subwoofer)**  
                                    **-15dB to +12dB (default: 2dB)**

---

**C Level (Center)**  
                                    **-12dB to +12dB (default: 0dB)**

---

### A/V Sync

When using progressive scanning on your DVD player, you may find that the picture and sound are out of sync. With this setting, you can correct this by delaying the audio signals.

**Note:**

This setting is not available when the Direct listening mode is used with an analog input signal.

---

**A/V Sync**      **0ms to 100ms in 20ms steps**

---





# Controlling Other Components

You can control your DVD player, CD player, and other components with the AV receiver's remote controller. To control another component, you must first enter that component's remote control code to a REMOTE MODE button.

This section explains how to enter remote control codes and how to control your other components.

## Preprogrammed Remote Control Codes

The following REMOTE MODE buttons are preprogrammed with remote control codes for controlling the components listed. You do not need to enter a remote control code to control these components. For details on controlling these components, see the pages indicated.

-  Onkyo DVD/BD player (page 62)
-  Onkyo CD player (page 63)
-  Onkyo cassette recorder with **RI** (page 65)
-  Onkyo RI Dock with **RI** (page 64)

## Entering Remote Control Codes

You'll need to enter a code for each component that you want to control.

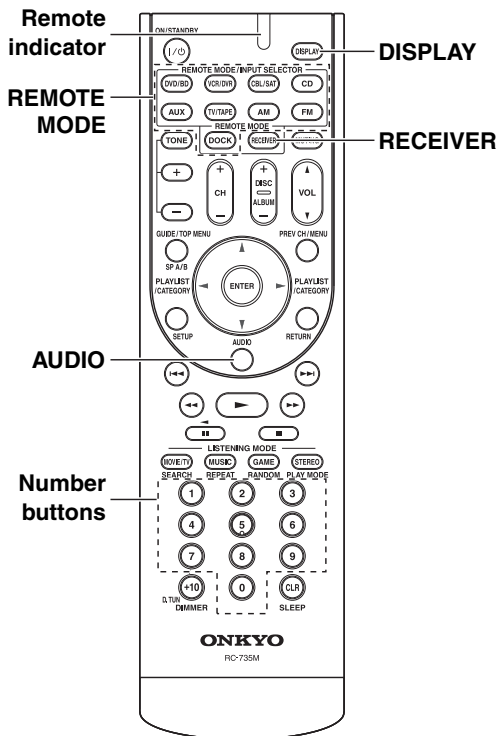

**1**

See page 61 for the Onkyo component's remote control code.

The codes are organized by category.

**2**



(3 seconds)

While holding down the REMOTE MODE button to which you want to enter a code, press and hold down the [DISPLAY] button until the Remote indicator lights up (about 3 seconds).

**Notes:**

- Remote control codes cannot be entered for the [RECEIVER] buttons.
- Apart from the [RECEIVER], [TV/TAPE] buttons, remote control codes from any category can be entered for the REMOTE MODE buttons. However, these buttons also work as input selector buttons (page 38), so choose a REMOTE MODE button that corresponds with the input to which you connect your component. For example, if you connect your CD player to the CD input, choose the [CD] button when entering its remote control code.

**3**

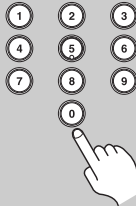

Within 30 seconds, use the number buttons to enter the 5-digit remote control code.

The Remote indicator flashes twice. If the remote control code is not entered successfully, the Remote indicator will flash once slowly.

**Note:**

The remote control codes provided are correct at the time of printing but subject to change.

## Controlling Other Components—Continued

### Remote Control Codes for Onkyo Components Connected via RI

Onkyo components that are connected via **RI** are controlled by pointing the remote controller at the AV receiver, not the component. This allows you to control components that are out of view, in a rack, for example.

- 1 Make sure the Onkyo component is connected with an RI cable and an analog audio cable (RCA).**  
See page 34 for details.
- 2 Enter the appropriate remote control code to the REMOTE MODE button.**
  - [DVD/BD] button  
**31612:** Onkyo DVD player with **RI**
  - [CD] button  
**71327:** Onkyo CD player with **RI**
  - [TV/TAPE] button  
**42157:** Onkyo cassette recorder with **RI** (default)
  - [DOCK] button  
**81993:** Onkyo RI Dock with **RI** (default)See the previous page for how to enter remote control codes.
- 3 Press the REMOTE MODE button, point the remote controller at the AV receiver, and operate the component.**

If you want to control an Onkyo component by pointing the remote controller directly at it, or you want to control an Onkyo component that's not connected via **RI**, use the following remote control codes:

- [DVD/BD] button  
**30627:** Onkyo DVD player without **RI** (default)  
**32900:** Onkyo BD player without **RI** (default)
- [CD] button  
**71817:** Onkyo CD player without **RI** (default)
- [DOCK] button  
**82990:** Onkyo RI Dock without **RI**

#### Note:

If you connect an **RI**-capable Onkyo MiniDisc recorder, CD recorder, or RI Dock to the TV/TAPE IN/OUT jacks, or connect an RI Dock to the CBL/SAT IN or VCR/DVR IN jacks, for **RI** to work properly, you must set the Input Display accordingly (see page 37).

### Resetting the REMOTE MODE Buttons

You can reset a REMOTE MODE button to its default remote control code.

- 1**  

**While holding down the REMOTE MODE button that you want to reset, press and hold down the [AUDIO] button until the Remote indicator lights up (about 3 seconds).**

(3 seconds)

- 2**  

**Within 30 seconds, press the REMOTE MODE button again.**  
The Remote indicator flashes twice, indicating that the button has been reset.

Each of the REMOTE MODE buttons is preprogrammed with a remote control code. When a button is reset, its preprogrammed code is restored.

### Resetting the Remote Controller

You can reset the remote controller to its default settings.

- 1**  

**While holding down the [RECEIVER] button, press and hold down the [AUDIO] button until the Remote indicator lights up (about 3 seconds).**

(3 seconds)

- 2**  

**Within 30 seconds, press the [RECEIVER] button again.**  
The Remote indicator flashes twice, indicating that the remote controller has been reset.

**Controlling a DVD Player, or DVD Recorder**

By pressing the REMOTE MODE button that's been programmed with the remote control code for your DVD player (HD DVD, Blu-ray, or TV/DVD combination), you can control your player with the following buttons.

The [DVD/BD] button is preprogrammed with the remote control code for controlling an Onkyo DVD player.

For details on entering a remote control code for a different component, see page 60.

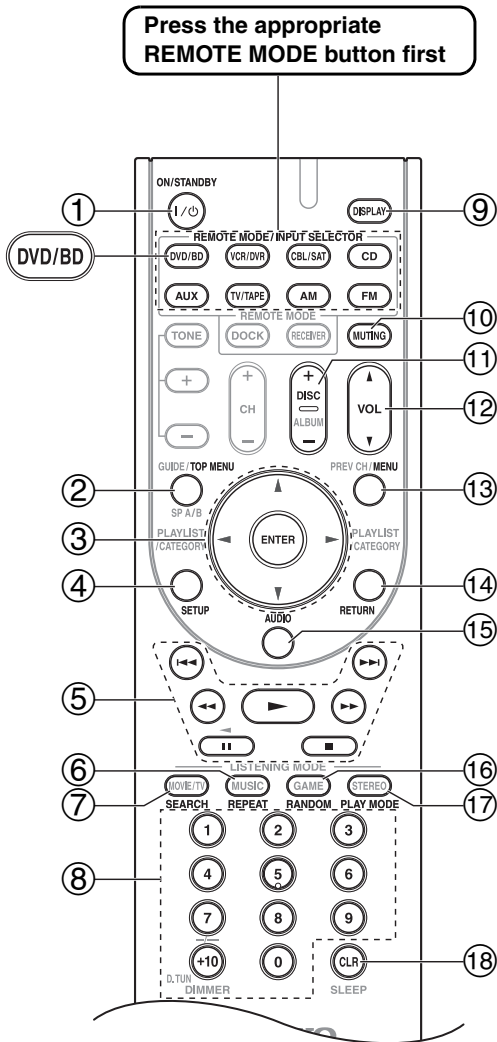

\* With some components, certain buttons may not work as expected, and some may not work at all.

- ① **ON/STANDBY button**  
Sets the DVD player to On or Standby.
- ② **TOP MENU button**  
Displays a DVD's top menu or a DVD's title.
- ③ **Arrow [▲]/[▼]/[◀]/[▶] and ENTER buttons**  
Used to navigate menus and select items.
- ④ **SETUP button**  
Used to access the DVD player's settings.

- ⑤ **Playback buttons**  
Play [▶], Pause [⏸], Stop [■], Fast Reverse [◀◀], Fast forward [▶▶], Previous [◀◀], and Next [▶▶].
- ⑥ **REPEAT button**  
Used with the repeat playback function.
- ⑦ **SEARCH button**  
Used to search title, chapter, and track numbers, and to search times for locating specific points.
- ⑧ **Number buttons**  
Used to enter title, chapter, and track numbers, and to enter times for locating specific points. The [+10] button works as a +10 button or “-.-” button.
- ⑨ **DISPLAY button**  
Displays information about the current disc, title, chapter, or track, including elapsed time, remaining time, total time, and so on.
- ⑩ **MUTING button (39)**  
Mutes or unmutes the AV receiver.
- ⑪ **DISC +/- button**  
Selects discs on a DVD changer.
- ⑫ **VOL [▲]/[▼] button (38)**  
Adjusts the volume of the AV receiver.
- ⑬ **MENU button**  
Displays a DVD's menu.
- ⑭ **RETURN button**  
Exits the DVD player's setup menu or returns to the previous menu.
- ⑮ **AUDIO button**  
Selects foreign language soundtracks and audio formats (e.g., Dolby Digital or DTS).
- ⑯ **RANDOM button**  
Used with the random playback function.
- ⑰ **PLAY MODE button**  
Selects play modes on components with selectable play modes.
- ⑱ **CLR button**  
Cancels functions and clears entered numbers.

**Note:**

If you enter the remote control code for a Blu-ray or HD DVD player that has A, B, C, and D or colored buttons, the [SEARCH], [REPEAT], [RANDOM], and [PLAY MODE] buttons will work as colored or A, B, C, D buttons. In this case, these buttons cannot be used to set repeat playback, random playback, or select play modes.

## Controlling a CD Player, CD Recorder, or MD Player

By pressing the REMOTE MODE button that's been programmed with the remote control code for your CD player, CD recorder, or MD player, you can control your player with the following buttons.

The [CD] button is preprogrammed with the remote control code for controlling an Onkyo CD player. For details on entering a remote control code for a different component, see page 60.

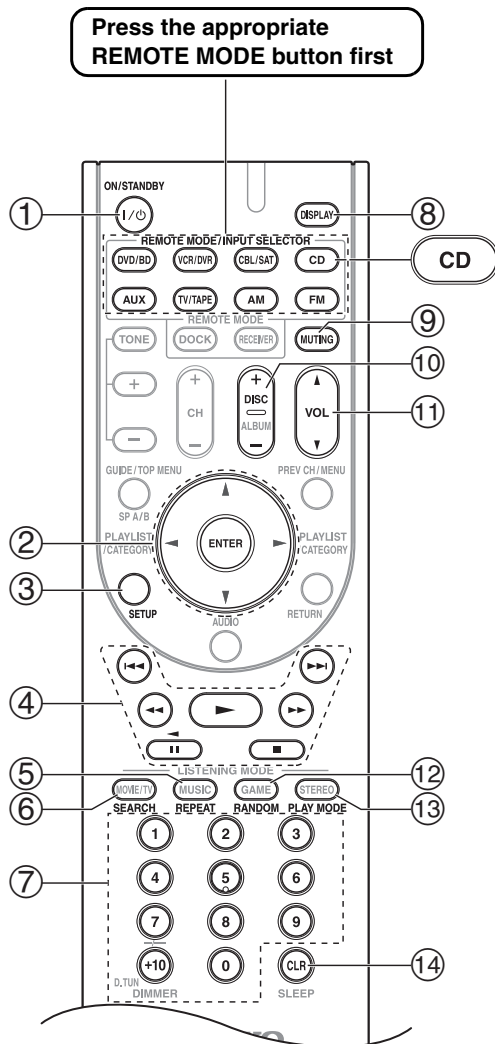

- ① **ON/STANDBY button**  
Set the component to On or Standby.
- ② **Arrow [▲]/[▼]/[◀]/[▶] and ENTER buttons**  
Used to navigate menus and select items.
- ③ **SETUP button**  
Used to access the Onkyo CD player's settings.
- ④ **Playback buttons**  
Play [▶], Pause [⏸], Stop [■], Fast Reverse [◀◀], Fast forward [▶▶], Previous [◀◀], and Next [▶▶].
- ⑤ **REPEAT button**  
Used with the repeat playback function.
- ⑥ **SEARCH button**  
Used to locate specific points.
- ⑦ **Number buttons**  
Used to enter track numbers and times for locating specific points. The [+10] button works as a +10 button or “-.-” button.
- ⑧ **DISPLAY button**  
Displays information about the current disc or track, including elapsed time, remaining time, total time, and so on.
- ⑨ **MUTING button (39)**  
Mutes or unmutes the AV receiver.
- ⑩ **DISC +/- button**  
Selects discs on a CD changer.
- ⑪ **VOL [▲]/[▼] button (38)**  
Adjusts the volume of the AV receiver.
- ⑫ **RANDOM button**  
Used with the random playback function.
- ⑬ **PLAY MODE button**  
Selects play modes on components with selectable play modes.
- ⑭ **CLR button**  
Cancels functions and clears entered numbers.

\* With some components, certain buttons may not work as expected, and some may not work at all.

**Controlling an RI Dock**

By pressing the REMOTE MODE button that's been programmed with the remote control code for your RI Dock, you can control your iPod in the RI Dock with the following buttons.

The [DOCK] button is preprogrammed with the remote control code for controlling an RI Dock when used with an **RI** connection.

For some RI docks, the "ON/STANDBY" button may not work with a remote control code **82990** (without RI). In this case, make an RI connection and enter a remote control code **81993** (with RI).

For details on entering a remote control code, see page 60.

**When Using an RI Dock:**

- Connect the RI Dock to the TV/TAPE IN, CBL/SAT IN, or VCR/DVR IN L/R jacks.
- Set the RI Dock's RI MODE switch to "HDD" or "HDD/DOCK".
- Set the AV receiver's Input Display to "DOCK" (see page 37).
- See to the RI Dock's instruction manual for more information.

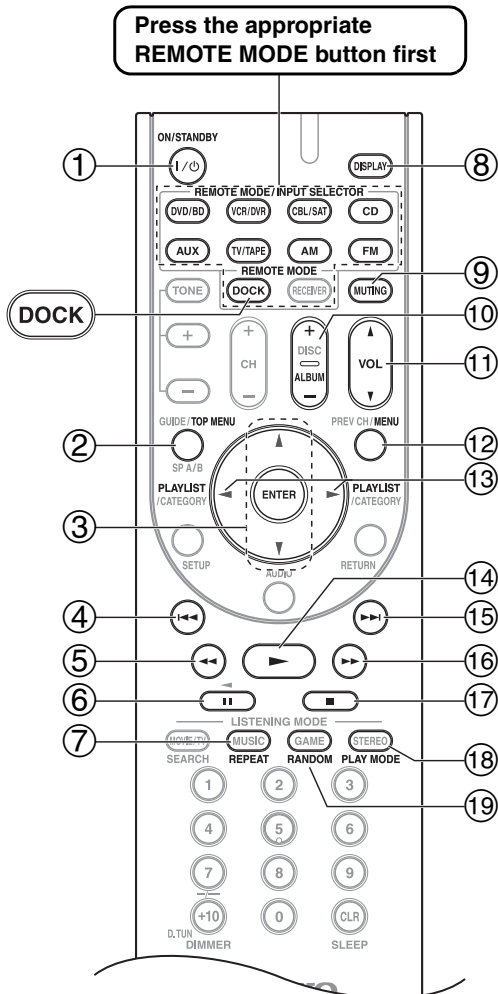

\* With some components, certain buttons may not work as expected, and some may not work at all.

- ON/STANDBY button**  
Turns the iPod on or off.  
**Notes:**
  - This button does not turn the Onkyo DS-A2 or DS-A2X RI Dock on or off.
  - Your iPod may not respond the first time you press this button, in which case you should press it again. This is because the remote controller transmits the On and Standby commands alternately, so if your iPod is already on, it will remain on when the remote controller transmits an On command. Similarly, if your iPod is already off, it will remain off when the remote controller transmits an Off command.
- TOP MENU button**  
Works as a Mode button when used with a DS-A2 RI Dock.
- Arrow [▲]/[▼] and ENTER buttons\***  
Used to navigate menus and select items.
- Previous [◀◀] button**  
Restarts the current song. Press it twice to select the previous song.
- Fast Reverse [◀◀] button**  
Press and hold to Fast Reverse.
- Pause [||] button**  
Pauses playback. (With 3rd generation iPod models, it works as a Play/Pause button.)
- REPEAT button\***  
Used with the repeat function.
- DISPLAY button\***  
Turns on the backlight for 30 seconds.
- MUTING button (39)**  
Mutes or unmutes the AV receiver.
- ALBUM +/- button\***  
Selects the next or previous album.
- VOL [▲]/[▼] button (38)**  
Adjusts the volume of the AV receiver.
- MENU button\***  
Displays a menu.
- PLAYLIST [◀]/[▶] buttons\***  
Selects the previous or next playlist on the iPod.
- Play [▶] button**  
Starts playback. If the component is off, it will turn on automatically. (With 3rd generation iPod models, this button works as a Play/Pause button.)
- Next [▶▶] button**  
Selects the next song.
- Fast Forward [▶▶] button**  
Press and hold to fast forward.
- Stop [■] button**  
Stops playback and displays a menu.



## Controlling Other Components—Continued

### ⑱ **PLAY MODE** button

Selects play modes on components with selectable play modes.  
Works as a Resume button when used with a DS-A2 RI Dock.

### ⑲ **RANDOM** button\*

Used with the shuffle function.

\* Buttons marked with an asterisk (\*) are not supported by 3rd generation iPod models.

## Controlling a Cassette Recorder

By pressing the REMOTE MODE button that's been programmed with the remote control code for your cassette recorder, you can control your cassette recorder with the following buttons.

The [TV/TAPE] button is preprogrammed with the remote control code for controlling an Onkyo cassette recorder when used with an **RI** connection.

For details on entering a remote control code for a different component, see page 60.

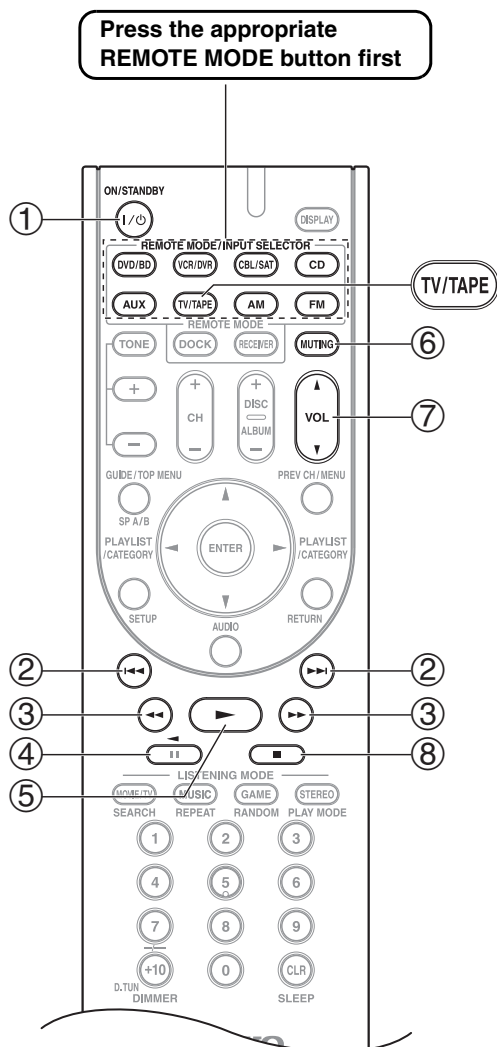

\* With some components, certain buttons may not work as expected, and some may not work at all.

On twin cassette decks, only Deck B can be controlled.

### ① **ON/STANDBY** button

Turns the cassette recorder on or off.

### ② **Previous and Next [I<<<I]/[>>>I] buttons**

The Previous [I<<<I] button selects the previous track. During playback it selects the beginning of the current track. The Next [>>>I] button selects the next track.

Depending on how they were recorded, the Previous and Next [I<<<I]/[>>>I] buttons may not work properly with some cassette tapes.

### ③ **Rewind and Fast Forward [ <<<I]/[ >>>I ] buttons**

The Rewind [ <<<I] button starts rewind. The Fast Forward [ >>>I] button starts fast forward.

### ④ **Reverse Play [ <<I] button**

Starts reverse playback.

### ⑤ **Play [ I>>I ] button**

Starts playback.

### ⑥ **MUTING** button (39)

Mutes or unmutes the AV receiver.

### ⑦ **VOL [ΔI]/[∇I] button (38)**

Adjusts the volume of the AV receiver.

### ⑧ **Stop [ ■I ] button**

Stops playback.

#### **Note:**

An Onkyo cassette recorder connected via **RI** can also be controlled in Receiver mode.

# Troubleshooting

If you have any trouble using the AV receiver, look for a solution in this section. If you can't resolve the issue yourself, contact your Onkyo dealer.

If you can't resolve the issue yourself, try resetting the AV receiver before contacting your Onkyo dealer.

**To reset the AV receiver to its factory defaults, turn it on and, while holding down the [VCR/DVR] button, press the [ON/STANDBY] button. "Clear" will appear on the display and the AV receiver will enter Standby mode.**

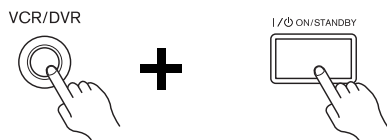

Note that resetting the AV receiver will delete your radio presets and custom settings.

## Power

### Can't turn on the AV receiver

- Make sure that the power cord is plugged into the wall outlet properly.
- Unplug the power cord from the wall outlet, wait 5 seconds or more, then plug it back in again.

### The AV receiver turns off as soon as it's turned on

- The amp protection circuit has been activated. Remove the power cord from the wall outlet immediately. Disconnect all speaker cables and input sources, and leave the AV receiver with its power cord disconnected for 1 hour. After that, reconnect the power cord and set the volume to maximum. If the AV receiver stays on, set the volume to minimum, disconnect the power cord, and reconnect your speakers and input sources. If the AV receiver turns off when you set the volume to maximum, disconnect the power cord, and contact your Onkyo dealer.

## Audio

### There's no sound or it's very quiet

- Press the SPEAKERS [A] or [B] button to turn on the indicator for the speakers that you want to output sound.
- HDMI audio is passed through the AV receiver and can only be heard from your TV.
- To listen to an audio source that's connected to an OPTICAL or COAXIAL input, make sure that input is assigned to an input selector (page 36).
- Make sure that all audio connecting plugs are pushed in all the way (page 21).
- Make sure that the polarity of the speaker cables is correct, and that the bare wire is in contact with the metal part of each speaker terminal (page 16).

- Make sure that the speaker cables are not shorting.
- Check the volume (page 38). The AV receiver is designed for home theater enjoyment and has a wide volume range for precise adjustment.
- If the MUTING indicator is flashing on the display, press the remote controller's [MUTING] button to unmute the AV receiver (page 39).
- While a pair of headphones is connected to the PHONES jack, no sound is output by the speakers (page 40).
- Check the digital audio output settings on the source component. On some game consoles, such as those that can play DVDs, the default setting is off.
- With some DVD-Video discs, you need to select an audio format from a menu or with the [AUDIO] button on your DVD player's remote controller.
- If your turntable doesn't have a phono preamp built-in, you must connect one between it and the AV receiver.
- If your turntable uses an MC cartridge, you must connect an MC head amp, or an MC transformer and a phono preamp.
- Check the speaker settings (pages 52–54).
- If the digital signal format is set to PCM or DTS, set it to "Auto" (page 41).

### Only the front speakers produce sound

- When the Stereo or Mono listening mode is selected, only the front speakers and subwoofer produce sound.
- Check the "3. Sp Config" (page 52).

### Only the center speaker produces sound

- If you use the Dolby Pro Logic II Movie or Dolby Pro Logic II Music listening mode with a mono source, such as an AM radio station or mono TV program, the sound will be concentrated in the center speaker.
- Check the "3. Sp Config" (page 52).

### The center speaker produces no sound

- When the Stereo or Mono listening mode is selected, the center speaker produces no sound (page 51).
- Check the "3. Sp Config" (page 52).

### The surround speakers produce no sound

- When the Stereo or Mono listening mode is selected, the surround speakers produce no sound.
- Depending on the source and the current listening mode, not much sound may be produced by the surround speakers. Try another listening mode (page 47).
- Check the "3. Sp Config" (page 52).

### The subwoofer produces no sound

- The subwoofer outputs no sound while only speaker set B is on. Turn on speaker set A.
- If the source material contains no audio in the LFE channel, the subwoofer produces no sound.
- Check the "3. Sp Config" (page 52).

- On the AV receiver, the subwoofer setting in the “3. Sp Config” is set to “No”. Set the subwoofer setting to “Yes”.

### **There’s no sound with a certain signal format**

- Check the digital audio output setting on the source component. On some game consoles, such as those that can play DVDs, the default setting is off.
- With some DVD-Video discs, you need to select an audio format from a menu or with the [AUDIO] button on your DVD player’s remote controller.

### **Can’t get 5.1-channel playback**

- When speaker B is turned on, speaker set A is reduced to 2.1-channel playback.

### **The volume cannot be set to 79**

- After the volume level of each individual speaker has been adjusted (page 54), the maximum volume may be reduced.
- When the levels of each speaker have been adjusted (page 54), the maximum possible volume may be reduced.

### **Noise can be heard**

- Using cable ties to bundle audio cables with power cords, speaker cables, and so on can degrade audio performance, so don’t use them.
- An audio cable may be picking up interference. Try repositioning your cables.

### **The Late Night function doesn’t work**

- Make sure that the source is Dolby Digital (page 58).

### **About DTS signals**

- When playing DTS program material, using the pause, fast forward, or fast reverse function on your player may produce a short audible noise. This is not a malfunction.
- When DTS program material ends and the DTS bitstream stops, the AV receiver remains in DTS listening mode and the DTS indicator remains on. This is to prevent noise when you use the pause, fast forward, or fast reverse function on your player. If you switch your player from DTS to PCM, as the AV receiver does not switch formats immediately, you may not hear anything, in which case you should stop your player for about 3 seconds, and then resume playback.
- With some CD players, you won’t be able to playback DTS material properly even though your player is connected to a digital input on the AV receiver. This is usually because the DTS bitstream has been processed (e.g., output level, sampling rate, or frequency response changed) and the AV receiver doesn’t recognize it as a genuine DTS signal. In such cases, you may hear noise.

## Video

### **There’s no picture**

- Make sure that all video connecting plugs are pushed in all the way (page 21).
- Make sure that each video component is properly connected.
- On your TV, make sure that the video input to which the AV receiver is connected is selected.
- The AV receiver does not convert between formats, so if a video source component is connected to a component video input, your TV must be connected to the component video output (page 22).
- If the video source is connected to an HDMI input, your TV must be connected to the HDMI OUT (page 22).

### **There’s no picture from a source connected to an HDMI IN**

- Reliable operation with an HDMI-to-DVI adapter is not guaranteed. In addition, video signals from a PC are not supported (page 24).
- If the message “Resolution Error” appears on the AV receiver’s display, this indicates that your TV does not support the current video resolution and you need to select another resolution on your DVD/BD player.

## Tuner

### **Reception is noisy, stereo FM reception suffers from hiss, or the FM STEREO indicator doesn’t light up**

- Relocate your antenna.
- Move the AV receiver away from your TV or computer.
- Listen to the station in mono (page 43).
- When listening to an AM station, operating the remote controller may cause noise.
- Passing cars and airplanes can cause interference.
- Concrete walls weaken radio signals.
- If nothing improves the reception, install an outdoor antenna.

## Remote Controller

### **The remote controller doesn’t work**

- Make sure that the batteries are installed with the correct polarity (page 14).
- Install new batteries. Don’t mix different types of batteries, or old and new batteries (page 14).
- Make sure that the remote controller is not too far away from the AV receiver and there’s no obstruction between the remote controller and the AV receiver’s remote control sensor (page 14).
- Make sure that the AV receiver is not subjected to direct sunshine or inverter-type fluorescent lights. Relocate if necessary.

- If the AV receiver is installed in a rack or cabinet with colored-glass doors, the remote controller may not work reliably when the doors are closed.
- Make sure you've selected the correct remote controller mode (pages 13 and 62–65).
- Make sure to set the same ID on both the AV receiver and remote controller (page 57).
- Make sure you've entered the correct remote control code (page 60).

### Can't control other components

- If it's an Onkyo component, make sure that the **RI** cable and analog audio cable are connected properly. Connecting only an **RI** cable won't work (page 34).
- Make sure you've selected the correct remote controller mode.
- If you've connected an **RI**-capable Onkyo MD recorder, CD recorder, or RI Dock to the TV/TAPE IN/OUT jacks, or an RI Dock to the CBL/SAT IN or VCR/DVR IN jacks, for the remote controller to work properly, you must set the Input Display to "MD", "CDR", or "DOCK", respectively (page 37).
- The entered remote control code may not be correct. If more than one code is listed, try each one.
- With some AV components, certain buttons may not work as expected, and some may not work at all.
- To control an Onkyo component that's connected via **RI**, point the remote controller at the AV receiver. Be sure to enter the appropriate remote control code first (page 61).

## Recording

### Can't record

- On your recorder, make sure the correct input is selected.
- To prevent signal loops and damage to the AV receiver, input signals are not fed through to outputs with the same name (e.g., TV/TAPE IN to TV/TAPE OUT or VCR/DVR IN to VCR/DVR OUT).

## Others

### The sound changes when I connect my headphones

- When a pair of headphones is connected, the listening mode is set to Stereo, unless it's already set to Stereo, Mono or Direct in which case it stays the same.

### How do I change the language of a multiplex source

- On the "7. Audio Adjust" menu, change the "Input (Mux)" setting to "Main" or "Sub" (page 55).

### The **RI** functions don't work

- To use **RI**, you must make an **RI** connection and an analog audio connection (RCA) between the component and AV receiver, even if they are connected digitally (page 34).

### The following settings can be made for the composite video inputs

You must use the buttons on the unit to make these settings.

1. While holding down the input selector button for the input source that you want to set, press the [SETUP] button.
2. Use the Left and Right [◀]/[▶] buttons to change the setting.
3. Press the [SETUP] button when you've finished.

### • Video Attenuation

This setting can be made for the DVD/BD, VCR/DVR, CBL/SAT, or AUX input.

If you have a games console connected to the composite video input, and the picture isn't very clear, you can attenuate the gain.

**Video ATT:0:** (default).

**Video ATT:2:** Gain is reduced by 2 dB.

The AV receiver contains a microcomputer for signal processing and control functions. In very rare situations, severe interference, noise from an external source, or static electricity may cause it to lockup. In the unlikely event that this happens, unplug the power cord from the wall outlet, wait at least 5 seconds, and then plug it back in again.

Onkyo is not responsible for damages (such as CD rental fees) due to unsuccessful recordings caused by this unit's malfunction. Before you record important data, make sure that the material will be recorded correctly.

Before disconnecting the power cord from the wall outlet, set the AV receiver to Standby.

# Specifications

## Amplifier Section

Rated Output Power

**All channels:**

**110 watts minimum continuous power per channel, 6 ohm loads, at 1kHz with a maximum total harmonic distortion of 1 %**

Maximum Output Power

Asian (JEITA): 1 ch×120 W at 6 ohms, 1 kHz, 1ch driven

Dynamic Power

160 W (3Ω, Front)

125 W (4Ω, Front)

85 W (8Ω, Front)

THD (Total Harmonic Distortion)

0.08% (1kHz, 1 W)

Damping Factor

60 (Front, 1kHz, 8Ω)

Input Sensitivity and Impedance

200 mV/ 47 kΩ (LINE)

Output Level and Impedance

200 mV/ 470 Ω (REC OUT)

Frequency Response

20Hz–50kHz/ +1 dB–3 dB (Direct)

Tone Control

±10 dB, 50Hz (BASS)

±10 dB, 20kHz (TREBLE)

Signal to Noise Ratio

100 dB (LINE, IHF-A)

Speaker Impedance

6Ω–16Ω

## Video Section

Input Sensitivity/Output Level and Impedance

1 V<sub>p-p</sub> /75Ω (Component Y)

0.7 V<sub>p-p</sub> /75Ω (Component Pb/Cb, Pr/Cr)

1 V<sub>p-p</sub> /75Ω (Composite)

Component Video Frequency Response

5Hz – 50MHz, –3 dB

## Tuner Section

FM Tuning Frequency Range

North American: 87.5MHz–107.9MHz

Asian: 87.5MHz–108.0MHz

AM Tuning Frequency Range

North American: 530kHz–1710kHz at 10 kHz steps

Asian: 522 kHz–1611 kHz at 9 kHz steps

530 kHz–1710 kHz at 10 kHz steps

Preset Channel

40

## General

Power Supply

North American: AC 120 V, 60Hz

Asian: AC 220-240 V, 50/60Hz

Power Consumption

North American: 3.4 A

Asian: 440 W

Dimensions

(W × H × D) 435 × 151.5 × 329 mm

17-1/8" × 5-15/16" × 12-15/16"

Weight

North American: 8.0 kg

17.6 lbs.

Asian: 9.1 kg

20.1 lbs.

### Video Inputs

HDMI IN 1, IN 2, IN 3

Component IN 1, IN 2

Composite CBL/SAT, VCR/DVR, DVD/BD

### Video Outputs

HDMI OUT

Component OUT

Composite VCR/DVR (REC OUT),

MONITOR OUT

### Audio Inputs

Digital Inputs COAXIAL:1

OPTICAL :2

Analog Inputs CD, TV/TAPE, CBL/SAT, VCR/DVR,

DVD/BD, AUX

### Audio Outputs

Analog Outputs TV/TAPE, VCR/DVR

Speaker Outputs SP-A (L, R), C, SL, SR, SW + SP-B (L, R)

Phones 1

Specifications and features are subject to change without notice.

### 5.1ch Home Theater Speaker Package

---

#### ■ Passive Subwoofer (SKW-370)

Type:	Bass-reflex type Passive subwoofer
Impedance:	6Ω
Maximum input power:	130 W
Output sound pressure level:	82 dB/W/m
Frequency response:	30 Hz–150 Hz
Cabinet capacity:	0.88 cubic feet (25 L)
Dimensions (W × H × D):	11-5/8" × 16-5/16" × 11-3/4" (295 × 414 × 299 mm)
Weight:	15.2 lbs. (6.9 kg)
Drivers unit:	8" (20 cm) Cone
Terminal:	Spring type color coded

#### ■ Front Speaker (SKF-370)

Type:	Full-Range Bass-reflex
Impedance:	6Ω
Maximum input power:	120 W
Output sound pressure level:	82 dB/W/m
Frequency response:	80 Hz–20 kHz
Cabinet capacity:	0.064 cubic feet (1.8 L)
Dimensions (W × H × D):	4" × 10-3/4" × 4-3/4" (101 × 273 × 121 mm)
Weight:	2.2 lbs. (1.0 kg)
Drivers unit:	3-1/4" (8 cm) Cone
Terminal:	Spring type color coded
Keyhole slot:	2
Grille:	Fixed
Other:	Magnetic shielding

#### ■ Center Speaker (SKC-370)

Type:	Full-Range Bass-reflex
Impedance:	6Ω
Maximum input power:	120 W
Output sound pressure level:	82 dB/W/m
Frequency response:	80 Hz–20 kHz
Cabinet capacity:	0.064 cubic feet (1.8 L)
Dimensions (W × H × D):	10-3/4" × 4" × 4-3/16" (273 × 101 × 106 mm)
Weight:	2.2 lbs. (1.0 kg)
Drivers unit:	3-1/4" (8 cm) Cone
Terminal:	Spring type color coded
Keyhole slot:	2
Grille:	Fixed
Other:	Magnetic shielding

#### ■ Center Speaker (SKC-370C)

Type:	Full-Range Bass-reflex
Impedance:	6Ω
Maximum input power:	120 W
Output sound pressure level:	85 dB/W/m
Frequency response:	80 Hz–20 kHz
Cabinet capacity:	0.064 cubic feet (1.8 L)
Dimensions (W × H × D):	10-3/4" × 4" × 4-3/16" (273 × 101 × 106 mm)
Weight:	3.1 lbs. (1.4 kg)
Drivers unit:	3-1/4" (8 cm) Cone × 2
Terminal:	Spring type color coded
Keyhole slot:	2
Grille:	Fixed
Other:	Magnetic shielding

#### ■ Surround Speaker (SKR-370)

Type:	Full-Range Bass-reflex
Impedance:	6Ω
Maximum input power:	120 W
Output sound pressure level:	81 dB/W/m
Frequency response:	80 Hz–20 kHz
Cabinet capacity:	0.039 cubic feet (1.1 L)
Dimensions (W × H × D):	4" × 6-7/8" × 4-9/16" (101 × 175 × 116 mm)
Weight:	1.5 lbs. (0.7 kg)
Drivers unit:	3-1/4" (8 cm) Cone
Terminal:	Spring type color coded
Keyhole slot:	1
Grille:	Fixed

Specifications and features are subject to change without notice.

# Memo

---



## **ONKYO CORPORATION**

Sales & Product Planning Div. : 2-1, Nisshin-cho, Neyagawa-shi, OSAKA 572-8540, JAPAN  
Tel: 072-831-8023 Fax: 072-831-8163

### **ONKYO U.S.A. CORPORATION**

18 Park Way, Upper Saddle River, N.J. 07458, U.S.A.  
Tel: 201-785-2600 Fax: 201-785-2650 <http://www.us.onkyo.com/>

### **ONKYO EUROPE ELECTRONICS GmbH**

Liegnitzerstrasse 6, 82194 Groebenzell, GERMANY  
Tel: +49-8142-4401-0 Fax: +49-8142-4401-555 <http://www.eu.onkyo.com/>

### **ONKYO EUROPE UK Office**

Suite 1, Gregories Court, Gregories Road, Beaconsfield, Buckinghamshire, HP9 1HQ  
UNITED KINGDOM Tel: +44-(0)1494-681515 Fax: +44(0)-1494-680452

### **ONKYO CHINA LIMITED**

Unit 1&12, 9/F, Ever Gain Plaza Tower 1, 88, Container Port Road, Kwai Chung,  
N.T., HONG KONG Tel: 852-2429-3118 Fax: 852-2428-9039  
<http://www.ch.onkyo.com/>



Y0901-1

SN 29344930

(C) Copyright 2009 ONKYO CORPORATION Japan. All rights reserved.





# QUICK SETUP

Model : HT-S3200



Thank you for purchasing this product. This quick setup sheet shows the typical hookup method for connecting speakers and AV components (DVD/BD player, TV, cable/satellite receiver). For more detailed hookup information and operating instructions, please see the Instruction Manual.

## First of all, turn on speaker set A.

Press the SPEAKERS [A] button on the front panel. Make sure that speaker indicator A is shown on the display.

Press the [RECEIVER] button, and then press the remote controller's [SP A/B] button repeatedly to select speaker set A. Make sure that speaker indicator A is shown on the display.

Turn off speaker set B when not in use. Indicator should be off.

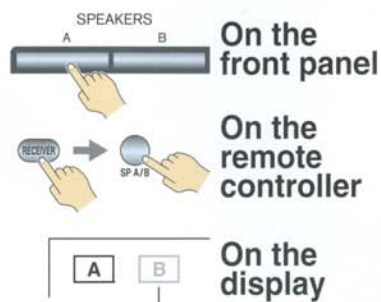

## Speaker Set A Layout (Main Room)

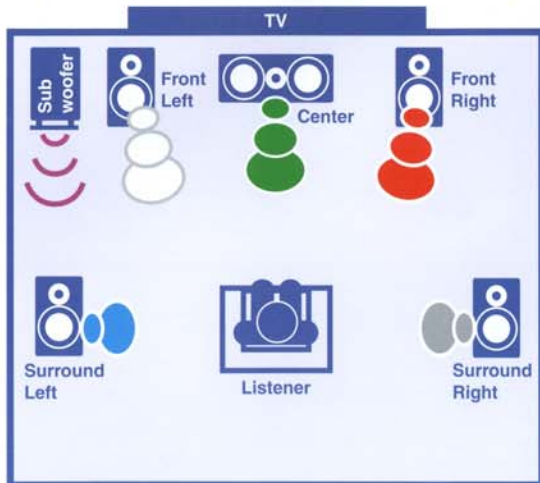

## Speaker Set A Hookup

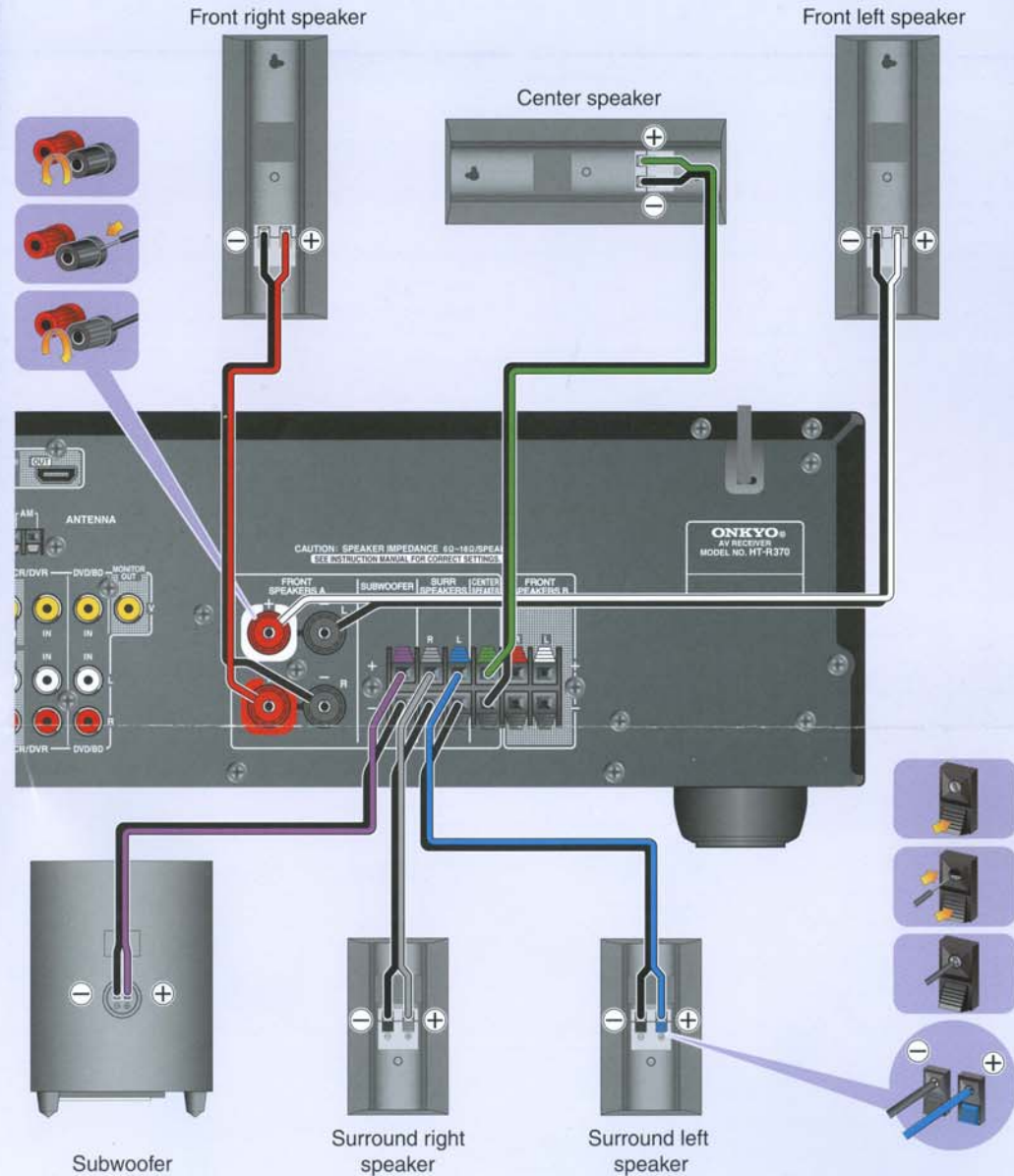

See the other side of this sheet for the AV component hookup.



HTP-370 speaker package is shown



# AV Component Hookup



If you have an HDMI-compatible TV and players, you can connect them to the AV receiver with HDMI cables. The audio and video signals received via the HDMI inputs are output by the HDMI OUT as they are (pass-through). To listen through the speakers connected to the AV receiver, please make the audio connections shown below.

IF NO HDMI



If your TV or player doesn't support HDMI, use the analog or digital connections shown below.

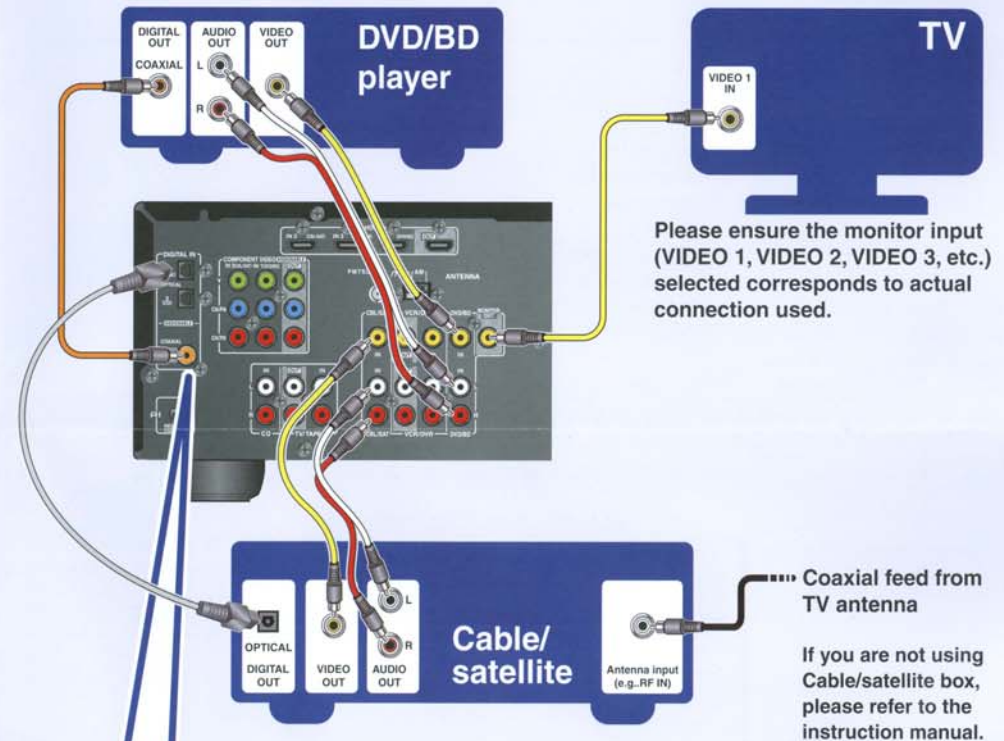
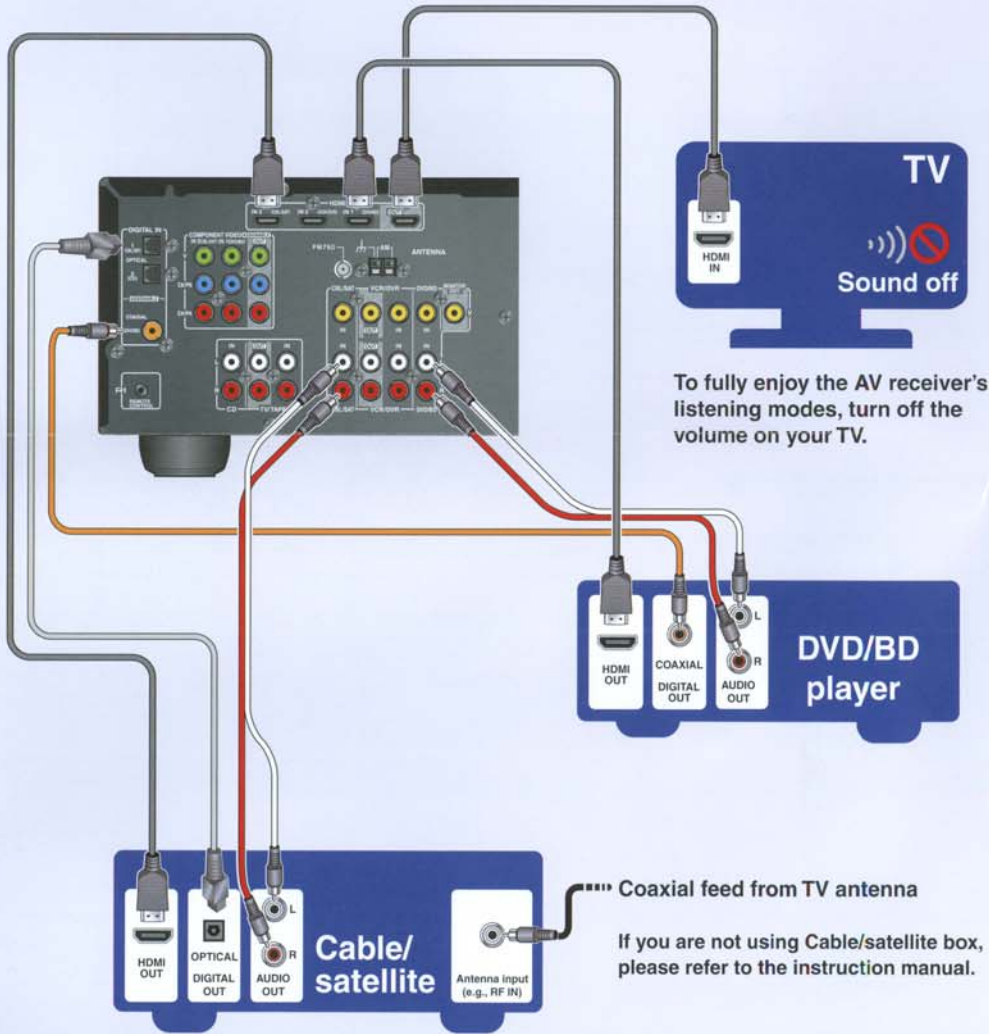

## Assigning the Digital Input

If there's no sound, you'll need to assign the digital inputs as necessary using the setup menus on the AV Receiver's display. If you connect your DVD/BD player to the AV receiver's COAXIAL DIGITAL IN, and your cable/satellite receiver to the OPTICAL 1 DIGITAL IN, as shown, it's not necessary to assign the digital input.

On the front panel

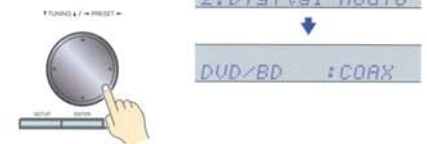



## Product Registration (USA and Canada)

### Product Registration

Thank you for purchasing this Onkyo product. In order to protect your investment and to receive information on new products and updates, please register. Please visit our web site for your online registration at :

[www.us.onkyo.com/prodreg\\_form.cfm](http://www.us.onkyo.com/prodreg_form.cfm) (For USA customers)

[www.onkyo.ca/prodreg\\_form.cfm](http://www.onkyo.ca/prodreg_form.cfm) (For Canadian customers)

### Online Customer Support

[www.onkyousa.com](http://www.onkyousa.com) can assist you anytime with Frequently Asked Questions, Hookup Diagrams, and Service Information. [www.onkyo.ca](http://www.onkyo.ca) is available for Canadian customer

#### We offer Product Support 7 days per week

Onkyo has extended its product support hours to a seven-day schedule. For questions, assistance, or comments, please call us or visit on our website at:

**Tel** 1-800-229-1687

**Web** [www.onkyousa.com/support](http://www.onkyousa.com/support) (For USA customers)

[www.onkyo.ca/support](http://www.onkyo.ca/support) (For Canadian customers)

#### Hours of Operation

Mon - Fri 9:00am - 8:00pm (Eastern Time)

Sat - Sun 10:00am - 4:00pm (Eastern Time)

#### Onkyo USA Corporation

18 Park Way, Upper Saddle River, NJ 07458

Phone: 201-785-2600 Fax: 201-934-7823

## Enregistrement du produit (États Unis et Canada)

### Enregistrement du produit

Nous vous remercions d'avoir acheté ce produit Onkyo. Pour protéger votre investissement et pour recevoir de l'information sur nos nouveaux produits ainsi que des mises à jour, veuillez enregistrer votre produit. Pour ce faire, consultez notre site Web aux adresses suivantes :

[www.us.onkyo.com/prodreg\\_form.cfm](http://www.us.onkyo.com/prodreg_form.cfm) (pour les clients des États Unis)

[www.onkyo.ca/prodreg\\_form.cfm](http://www.onkyo.ca/prodreg_form.cfm) (pour les clients du Canada)

### Soutien à la clientèle en ligne

Vous pouvez obtenir de l'aide en tout temps sur le site [www.onkyousa.com](http://www.onkyousa.com) en consultant les sections *Frequently Asked Questions*, *Hookup Diagrams* et *Service Information*. Les clients canadiens peuvent quant à eux consulter le site [www.onkyo.ca](http://www.onkyo.ca).

#### Nous offrons un soutien technique 7 jours sur 7

Onkyo offre maintenant un soutien technique 7 jours sur 7. Pour obtenir de l'aide, des réponses à vos questions, ou pour soumettre vos commentaires, veuillez communiquer avec nous par téléphone ou consulter notre site Web :

**Téléphone** 1-800-229-1687

**Sites Web** [www.onkyousa.com/support](http://www.onkyousa.com/support) (pour les clients des États Unis)

[www.onkyo.ca/support](http://www.onkyo.ca/support) (pour les clients du Canada)

#### Heures d'ouverture

Lundi au vendredi de 9 h 00 à 20 h 00 (heure de l'Est)

Samedi et dimanche de 10 h 00 à 16 h 00 (heure de l'Est)

#### Onkyo USA Corporation

18 Park Way, Upper Saddle River, NJ 07458

Téléphone: 201-785-2600 Télécopieur: 201-934-7823

SN:29365135

# ONKYO USA Corporation Limited Warranty (USA)

PLEASE RETAIN YOUR ORIGINAL BILL OF SALE AS YOU WILL NEED TO PRESENT IT SHOULD YOU REQUIRE SERVICE UNDER THIS WARRANTY. Onkyo USA Corporation (hereinafter referred to as Onkyo) hereby warrants all Onkyo products **PURCHASED DIRECTLY FROM ONKYO OR AN ONKYO AUTHORIZED INDEPENDENT DEALER**, in accordance with the following terms and conditions:

## Warranty Period (from date of purchase):

To verify current model's warranty period, please visit [www.us.onkyo.com/warranty.cfm](http://www.us.onkyo.com/warranty.cfm) or call us **1-800-229-1687**.

Receivers, and Amplifiers	2 years Parts & Labor
DVD Players, Tuners, Speakers	2 years Parts & Labor
CD Players, Cassette Decks, Personal Audio Systems	1 year Parts & Labor
Multimedia Products, Audio/Video Accessories	1 year Parts & Labor

## Scope of Warranty

From the date of original purchase and for the respective periods specified above, Onkyo agrees to repair, at its sole expense, all Onkyo products purchased directly from Onkyo or an Onkyo Authorized Independent Dealer, which are defective in material and/or workmanship.

### EXCLUSIONS:

**IF YOU PURCHASE AN ONKYO PRODUCT FROM AN UNAUTHORIZED DEALER, YOUR ONKYO WARRANTY MAY NOT BE VALID, please use our authorized dealer locator.**

### This Warranty does not cover the following:

1. Defects or damage caused by accident, fire, flood or other water damage, lightning or other acts of God.
2. Defects or damage caused by abuse, misuse, negligence or failure to observe the instructions contained in the manual furnished at the time of original purchase.
3. Damage caused during shipment or handling.
4. Products purchased from anyone other than Onkyo or an Onkyo Authorized Independent Dealer. If you are uncertain as to whether a dealer is authorized, please contact Onkyo's Customer Relations Department or check the Dealer and Service Locator.
5. Products that have had their serial numbers altered or removed.
6. Products purchased in "AS IS" condition.
7. Products that have been altered or repaired by anyone other than Onkyo or an Onkyo authorized independent service station in a manner that has affected their performance, stability or reliability.
8. Accessories attached to or to be used with Onkyo products, such as antennas, batteries, cables, or media such as CD's, DVD's, etc.
9. Packing materials and cosmetic items.
10. Parts which have prescribed useful lives dependent upon the degree of their use, such as batteries, cassette heads, idler wheels, etc.
11. Installation and removal of Onkyo products.
12. Maintenance, cleaning or periodic check-ups.
13. Signal reception problems whether caused by external antennas, satellite, or cable systems or the physical location of the unit.
14. Damage caused by or to other equipment not properly connected to the unit.
15. Adjustments or alterations required for compatibility with conditions pertaining to foreign countries.
16. Products used continuously or for commercial applications. Onkyo products are intended for consumer use and are not designed for continuous or commercial use. In the event that the products concerned have been used commercially or continuously, the warranty period is limited to 90 days from the date of purchase.

### Obtaining Warranty Service:

To obtain warranty service, take or ship your Onkyo product to an Onkyo Authorized Independent Service Center, together with a note describing your complaint and your copy of the dated purchase receipt. Please also include in any mailing a contact name, address and telephone number. If you choose to ship your Onkyo product to an Onkyo Authorized Independent Service Center, all shipping arrangements must be made by you and all shipping charges and insurance must be fully prepaid. Any Onkyo product shipped in its entirety must be shipped in its original carton. Onkyo will pay all return shipping charges for Onkyo products that have been serviced under this warranty. Any service or repair for items not covered by this limited warranty shall be at the Authorized Independent Service Center's rates and terms then in effect. Contact an Onkyo Authorized Service Center for details.

### Limitations:

Onkyo makes this warranty subject to the following limitations:

1. This Warranty is valid only within the territory of the United States of America. To be covered by this warranty the Onkyo product concerned must have been purchased directly from Onkyo or an Onkyo Authorized Dealer in the United States and the person seeking warranty service must reside in one of the states of the United States of America or in the District of Columbia. This warranty extends only to the original purchaser and cannot be transferred to anyone.
2. ONKYO SHALL HAVE NO LIABILITY WHATSOEVER FOR INCIDENTAL OR CONSEQUENTIAL DAMAGES. THE RESPONSIBILITY OF ONKYO UNDER THIS WARRANTY SHALL BE LIMITED TO THE REPAIR OF DEFECTIVE ONKYO PRODUCTS BY ONKYO OR ITS AUTHORIZED INDEPENDENT SERVICE STATIONS.
3. This warranty is valid only with respect to repairs affected by Onkyo or an Onkyo Authorized Independent Service Station.
4. ALL WARRANTIES AND CONDITIONS OTHER THAN THE EXPRESS WARRANTY HEREIN CONTAINED INCLUDING BUT NOT LIMITED TO ANY IMPLIED WARRANTY OF MERCHANTABILITY OR FITNESS FOR A PARTICULAR PURPOSE ARE LIMITED IN DURATION TO THE APPLICABLE WARRANTY PERIOD SET FORTH ABOVE.

Some states do not allow limitations on how long an implied warranty or condition lasts and some states do not allow the exclusion or limitation of incidental or consequential damages, so the above limitations or exclusion may not apply to you. This warranty gives you specific legal rights and you may also have other rights that vary from state to state.

# ONKYO USA Corporation Limited Warranty (Canada)

PLEASE RETAIN YOUR ORIGINAL BILL OF SALE AS YOU WILL NEED TO PRESENT IT SHOULD YOU REQUIRE SERVICE UNDER THIS WARRANTY. Onkyo USA Corporation (hereinafter referred to as Onkyo) hereby warrants all Onkyo products **PURCHASED DIRECTLY FROM ONKYO OR AN ONKYO AUTHORIZED INDEPENDENT DEALER**, in accordance with the following terms and conditions:

## Warranty Period (from date of purchase):

To verify current model's warranty period, please visit [www.onkyo.ca/warranty.cfm](http://www.onkyo.ca/warranty.cfm) or call us **1-800-229-1687**.

Receivers, and Amplifiers	2 years Parts & Labor
DVD Players, Tuners, Speakers	2 years Parts & Labor
CD Players, Cassette Decks, Personal Audio Systems	1 year Parts & Labor
Multimedia Products, Audio/Video Accessories	1 year Parts & Labor

## Scope of Warranty

From the date of original purchase and for the respective periods specified above, Onkyo agrees to repair, at its sole expense, all Onkyo products purchased directly from Onkyo or an Onkyo Authorized Independent Dealer, which are defective in material and/or workmanship.

### EXCLUSIONS:

**IF YOU PURCHASE AN ONKYO PRODUCT FROM AN UNAUTHORIZED DEALER, YOUR ONKYO WARRANTY MAY NOT BE VALID, please use our authorized dealer locator.**

### This Warranty does not cover the following:

1. Defects or damage caused by accident, fire, flood or other water damage, lightning or other acts of God.
2. Defects or damage caused by abuse, misuse, negligence or failure to observe the instructions contained in the manual furnished at the time of original purchase.
3. Damage caused during shipment or handling.
4. Products purchased from anyone other than Onkyo or an Onkyo Authorized Independent Dealer. If you are uncertain as to whether a dealer is authorized, please contact Onkyo's Customer Relations Department or check the Dealer and Service Locator.
5. Products that have had their serial numbers altered or removed.
6. Products purchased in "AS IS" condition.
7. Products that have been altered or repaired by anyone other than Onkyo or an Onkyo authorized independent service station in a manner that has affected their performance, stability or reliability.
8. Accessories attached to or to be used with Onkyo products, such as antennas, batteries, cables, etc.
9. Packing materials and cosmetic items.
10. Parts which have prescribed useful lives dependent upon the degree of their use, such as batteries, cassette heads, idler wheels, etc.
11. Installation and removal of Onkyo products.
12. Maintenance, cleaning or periodic check-ups.
13. Adjustments or alterations required for compatibility with conditions pertaining to foreign countries.
14. Products used continuously or for commercial applications. Onkyo products are intended for consumer use and are not designed for continuous or commercial use. In the event that the products concerned have been used commercially or continuously, the warranty period is limited to 90 days from the date of purchase.

### Obtaining Warranty Service:

To obtain warranty service, take or ship your Onkyo product to an Onkyo Authorized Independent Service Center in Canada, together with a note describing your complaint and your copy of the dated purchase receipt. Please also include in any mailing a contact name, address and telephone number. If you choose to ship your Onkyo product to an Onkyo Authorized Independent Service Center, all shipping arrangements must be made by you and all shipping charges and insurance must be fully prepaid. Any Onkyo product shipped in its entirety must be shipped in its original carton. Onkyo will pay all return shipping charges for Onkyo products that have been serviced under this warranty. Any service or repair for items not covered by this limited warranty shall be at the Authorized Independent Service Center's rates and terms then in effect. Contact an Onkyo Authorized Service Center for details.

### Limitations:

Onkyo makes this warranty subject to the following limitations:

1. This Warranty is valid only within Canada. To be covered by this warranty the Onkyo product concerned must have been purchased directly from Onkyo or an Onkyo Authorized Dealer in Canada and the person seeking warranty service must reside in Canada. This warranty extends only to the original purchaser and cannot be transferred to anyone.
2. ONKYO SHALL HAVE NO LIABILITY WHATSOEVER FOR INCIDENTAL OR CONSEQUENTIAL DAMAGES. THE RESPONSIBILITY OF ONKYO UNDER THIS WARRANTY SHALL BE LIMITED TO THE REPAIR OF DEFECTIVE ONKYO PRODUCTS BY ONKYO OR ITS AUTHORIZED INDEPENDENT SERVICE STATIONS.
3. This warranty is valid only with respect to repairs affected by Onkyo or an Onkyo authorized independent service station.
4. ALL WARRANTIES AND CONDITIONS OTHER THAN THE EXPRESS WARRANTY HEREIN CONTAINED INCLUDING BUT NOT LIMITED TO ANY IMPLIED WARRANTY OF MERCHANTABILITY OR FITNESS FOR A PARTICULAR PURPOSE ARE LIMITED IN DURATION TO THE APPLICABLE WARRANTY PERIOD SET FORTH ABOVE. Some jurisdictions do not allow limitations on how long an implied warranty or condition lasts and/or do not allow the exclusion or limitation of incidental or consequential damages, so the above limitations or exclusion may not apply to you. This warranty gives you specific legal rights and you may also have other rights that vary from province to province.

# Garantie limitée de ONKYO USA Corporation (Canada)

VEUILLEZ CONSERVER VOTRE FACTURE ORIGINALE PUISQUE VOUS DEVREZ LA PRÉSENTER POUR VOUS PRÉVALOIR DU SERVICE AUX TERMES DE LA PRÉSENTE GARANTIE. Onkyo USA Corporation (ci après Onkyo) garantit par les présentes tous les produits Onkyo **ACHETÉS DIRECTEMENT AUPRÈS DE ONKYO OU D'UN MARCHAND INDÉPENDANT AUTORISÉ DE ONKYO**, conformément aux modalités suivantes :

## Durée de la garantie (à compter de la date d'achat):

Pour vérifier la durée de la garantie de votre modèle, veuillez consulter le site [www.onkyo.ca/warranty.cfm](http://www.onkyo.ca/warranty.cfm) ou communiquer avec nous par téléphone au **1-800-229-1687**.

Récepteurs et amplificateurs	2 ans pièces et main-d'œuvre
Lecteurs DVD, syntoniseurs et haut-parleurs	2 ans pièces et main-d'œuvre
Lecteurs CD, platines à cassettes et systèmes audio personnels	1 an pièces et main-d'œuvre
Produits multimédias et accessoires audio et vidéo	1 an pièces et main-d'œuvre

## Portée de la garantie

À compter de la date de l'achat initial et durant les périodes précisées ci dessus, Onkyo accepte de réparer, à ses frais, tous les produits Onkyo défectueux ou qui présentent des vices de fabrication achetés directement auprès d'elle ou auprès d'un marchand indépendant autorisé de Onkyo.

## EXCLUSIONS:

**SI VOUS ACHETEZ UN PRODUIT ONKYO AUPRÈS D'UN MARCHAND NON AUTORISÉ, LA GARANTIE ONKYO POURRAIT NE PAS ÊTRE VALIDE. Veuillez consulter la liste de nos marchands autorisés.**

## La présente garantie ne couvre pas les éléments suivants

1. Les défauts ou les dommages causés par un accident, un incendie, une inondation ou autre infiltration d'eau, un orage ou toute autre catastrophe naturelle.
2. Les défauts ou les dommages causés par un usage abusif, une mauvaise utilisation, une négligence ou le défaut de suivre les instructions du manuel fourni au moment de l'achat initial.
3. Les dommages causés au cours de la livraison ou la manutention.
4. Les produits achetés auprès d'une personne autre que Onkyo ou qu'un marchand indépendant autorisé de Onkyo. Si vous ignorez si un marchand est autorisé, veuillez communiquer avec le service à la clientèle de Onkyo ou consulter la liste des marchands et fournisseurs de services autorisés.
5. Les produits dont le numéro de série a été modifié ou effacé.
6. Les produits achetés « tel quel ».
7. Les produits qui ont été modifiés ou réparés par une personne autre que Onkyo ou qu'un fournisseur de services indépendant autorisé de Onkyo de façon à affecter leur rendement, leur durabilité ou leur fiabilité.
8. Les accessoires attachés aux produits Onkyo ou devant être utilisés avec ceux ci, comme les antennes, les batteries, les câbles, etc.
9. Les matériaux d'emballage et les éléments de présentation.
10. Les pièces qui ont une durée de vie utile prescrite en fonction de leur utilisation, comme les batteries, les têtes de lecture, les engrenages, etc.
11. L'installation et le démontage des produits Onkyo.
12. L'entretien, le nettoyage ou les mises au point périodiques.
13. Les ajustements ou les modifications nécessaires pour assurer la conformité aux normes de pays étrangers.
14. Les produits utilisés sans interruption ou à des fins commerciales. Les produits Onkyo sont destinés aux consommateurs et ils ne sont pas conçus pour un usage ininterrompu ou commercial. Si les produits en cause ont été utilisés à des fins commerciales ou sans interruption, la durée de la garantie est limitée à 90 jours à compter de la date de l'achat.

## Exécution de la garantie:

Pour faire exécuter la garantie, veuillez remettre ou poster votre produit Onkyo à un centre de service indépendant autorisé de Onkyo au Canada, avec une note décrivant le problème et votre reçu d'achat daté. Pour tout envoi postal, veuillez également fournir le nom de la personne à contacter, son adresse et son numéro de téléphone. Si vous choisissez d'expédier votre produit Onkyo à un centre de services indépendant autorisé de Onkyo, vous devez prendre les dispositions nécessaires pour assurer la livraison et régler d'avance l'ensemble des frais et des assurances liés à la livraison. Tout produit Onkyo complet doit être expédié dans son emballage d'origine. Onkyo remboursera les frais d'expédition de retour pour les produits Onkyo sous garantie. Les services fournis ou les réparations effectuées à l'égard d'articles qui ne sont pas couverts par la présente garantie limitée seront effectués selon les tarifs et les modalités en vigueur du centre de services indépendant autorisé. Pour obtenir plus de détails, communiquez avec un centre de services autorisés de Onkyo.

## Limitations de la garantie:

La présente garantie de Onkyo est assujettie aux limitations suivantes :

1. La présente garantie n'est valide qu'au Canada. Pour être couvert par la présente garantie, le produit Onkyo en cause doit être acheté directement auprès de Onkyo ou d'un marchand autorisé Onkyo au Canada et la personne qui désire se prévaloir de la garantie doit être un résident du Canada. La présente garantie ne vise que l'acheteur d'origine et elle ne peut être cédée à une autre personne.
2. ONKYO N'ASSUME AUCUNE RESPONSABILITÉ EN CAS DE DOMMAGES CONSÉCUTIFS OU INDIRECTS. LA RESPONSABILITÉ DE ONKYO AUX TERMES DE LA PRÉSENTE GARANTIE SE LIMITE À LA RÉPARATION DES PRODUITS ONKYO DÉFECTUEUX PAR ONKYO OU PAR SES CENTRES DE SERVICE INDÉPENDANTS AUTORISÉS.
3. La présente garantie n'est valide qu'à l'égard des réparations effectuées par Onkyo ou par un centre de services indépendant autorisé de Onkyo.
4. À L'EXCEPTION DES GARANTIES EXPRESSÉMENT CITÉES AUX PRÉSENTES, Y COMPRIS TOUTE GARANTIE IMPLICITE DE QUALITÉ MARCHANDE OU D'APTITUDE À UN USAGE PARTICULIER, TOUTES LES GARANTIES ET LES MODALITÉS SONT D'UNE DURÉE LIMITÉE CONFORMÉMENT À LA DURÉE DE LA GARANTIE APPLICABLE SUSMENTIONNÉE.

Certains territoires n'autorisent aucune restriction sur les garanties implicites ni l'exclusion ou la limitation des dommages consécutifs ou indirects de sorte que les limitations ou les exclusions susmentionnées pourraient ne pas s'appliquer dans votre cas. La présente garantie vous donne des droits légaux précis et vos droits pourraient varier selon les provinces.